



UROLOGIE

**REDA**

INSTRUMENTE GMBH

## Reda Instrumente GmbH

Gänsäcker 34 - P.O. Box 131  
D-78532 Tuttlingen

Telefon +49/7462/9445-0  
Telefax +49/7462/9445-20  
e-mail: [info@Reda-Instrumente.de](mailto:info@Reda-Instrumente.de)  
<http://www.Reda-Instrumente.de>

Ausgabe Nr. 1  
Datum: 2013

Charrière (Ch) French (F)	Durchmesser in mm	Inches
1	0,33	0,013
2	0,67	0,025
3	1,00	0,039
4	1,33	0,051
5	1,67	0,065
6	2,00	0,0787
7	2,33	0,092
8	2,67	0,105
9	3,00	0,1181
10	3,33	0,131
11	3,67	0,144
12	4,00	0,1575
13	4,33	0,170
14	4,67	0,184
15	5,00	0,1968
16	5,33	0,210
17	5,67	0,223
18	6,00	0,2362
19	6,33	0,249
20	6,67	0,263
21	7,00	0,2756
22	7,33	0,288
23	7,67	0,302
24	8,00	0,3150
25	8,33	0,328
26	8,67	0,341
27	9,00	0,3543
28	9,33	0,367
29	9,67	0,380
30	10,00	0,3973
31	10,33	0,407
32	10,67	0,420
34	11,33	0,446
36	12,00	0,4724
38	12,67	0,494
40	13,33	0,5199
45	15,00	0,5905

Gauge (G)	Durchmesser in mm	Inches
35	0,13	0,005
34	0,18	0,007
33	0,20	0,008
32	0,23	0,009
31	0,25	0,010
30	0,30	0,012
29	0,33	0,013
28	0,36	0,014
27	0,41	0,016
26	0,46	0,018
25	0,51	0,020
	0,53	0,021
24	0,56	0,022
23	0,64	0,025
22	0,71	0,028
21	0,81	0,032
20	0,89	0,035
	0,97	0,038
19	1,07	0,042
18	1,27	0,050
17	1,50	0,059
16	1,65	0,065
15	1,83	0,072
14	2,11	0,083
13	2,41	0,095
12	2,77	0,109
11	3,05	0,120
10	3,40	0,134
9	3,76	0,148
8	4,19	0,165
7	4,57	0,180
6	5,16	0,203

1 OZ	0,028 ml
5 OZ	0,140 ml
16 OZ	0,450 ml

35 OZ	1,0 l
128 OZ	3,7 l

## GARANTIE / WARRANTY / GARANTIA / GARANZIA

### GARANTIE

Wir gewähren auf alle **Reda**-Instrumente 5 Jahre Garantie. Voraussetzung ist der sach- und fachgerechte Einsatz der Instrumente.

Von der Garantie sind Verschleißerscheinungen ausgeschlossen.

### WARRANTY

Our **Reda** products are free from manufacturing defects in material and workmanship. We therefore give on all instruments a guarantee of five years provided that the instruments are maintained and cleaned properly and used normally for their intended purpose.

### GARANTIA

Estamos convencidos de nuestra calidad y concedemos a todos los instrumentos de **Reda** 5 años de garantía contra cualquier defecto de fabricación, siempre y cuando se usen adecuadamente. De la garantía excluimos la manifestación de desgaste.

### GARANZIA

Siamo convinti della nostra qualità e concediamo cinque anni di garanzia sulla funzione dei tutti gli strumenti **Reda** sotto la presupposizione che l'utilizzo è da esperto.

Escluso della garanzia sono tracce di consumo.

OPTIKEN	7 - 8
TELESCOPES	
ÓPTICAS	
OTTICHE	
<hr/>	
CYSTOSKOPIE	9 - 20
CYSTOSCOPY	
CISTOSCOPIA	
CISTOSCOPIA	
<hr/>	
RESEKTOSKOPIE	21 - 28
RESECTOSCOPY	
RESECTOSCOPIA	
RESETTOSCOPIA	
<hr/>	
URETHROTOM	29 - 32
URETHROTOME	
URETRÓTOMO	
URETROTOMO	
<hr/>	
CYSTOSKOPIE FÜR 2,9 MM Ø OPTIK	33 - 38
CYSTOSCOPY FOR 2,9 MM Ø OPTIC	
CISTOSCOPIA PARA ÓPTICA 2,9 MM Ø	
CISTOSCOPIA PER OTTICA 2,9 MM Ø	
<hr/>	
RESEKTOSKOPIE FÜR 2,9 MM Ø OPTIK	39 - 46
RESECTOSCOPY FOR 2,9 MM Ø OPTIC	
RESECTOSCOPIA PARA ÓPTICA 2,9 MM Ø	
RESETTOSCOPIA PER OTTICA 2,9 MM Ø	
<hr/>	
URETHROTOMIE FÜR 2,9 MM Ø OPTIK	47 - 50
URETHROTOMY FOR 2,9 MM Ø OPTIC	
URETRÓTOMO PARA ÓPTICA 2,9 MM Ø	
URETROTOMO PER OTTICA 2,9 MM Ø	
<hr/>	
PÄDIATRISCHE UROLOGIE / CYSTOSKOPIE UND RESEKTOSKOPIE, 9,5 & 11 CHAR Ø	51 - 56
PEDIATRIC UROLOGY / CYSTOSCOPY AND RESECTOSCOPY, 9,5 & 11 FR. Ø	
UROLOGÍA PEDIÁTRICA / CISTOSCOPIA Y RESECTOSCOPIA, 9,5 & 11 CHAR Ø	
UROLOGIA PEDIATRICA / CISTOSCOPIA E RESETTOSCOPIA, 9,5 & 11 CHAR Ø	

---

PÄDIATRISCHE UROLOGIE / CYSTOSKOPIE UND RESEKTOSKOPIE, 13 CHAR Ø	57 - 62
PEDIATRIC UROLOGY / CYSTOSCOPY AND RESECTOSCOPY, 13 FR. Ø	
UROLOGÍA PEDIÁTRICA / CISTOSCOPIA Y RESECTOSCOPIA, 13 CHAR Ø	
UROLOGIA PEDIATRICA / CISTOSCOPIA E RESECTOSCOPIA, 13 CHAR Ø	

---

NEPHROSKOPIE	63 - 66
NEPHROSCOPY	
NEFROSCOPIA	
NEFROSCOPIA	

---

URETERO-RENSKOPIE	67 - 72
URETERO-RENSCOPY	
URETERO-RENSCOPIA	
URETERO-RENSCOPIA	

---

ZUBEHÖR	73 - 78
ACCESSORIES	
ACCESORIOS	
ACCESSORI	

---

NUMMERNVERZEICHNIS	79 - 81
NUMERICAL INDEX	
INDICE NUMÉRICO	
INDICE NUMERICO	

---

**Reda Instrumente GmbH**  
Gänsäcker 34 - P.O. Box 131  
D-78532 Tuttlingen

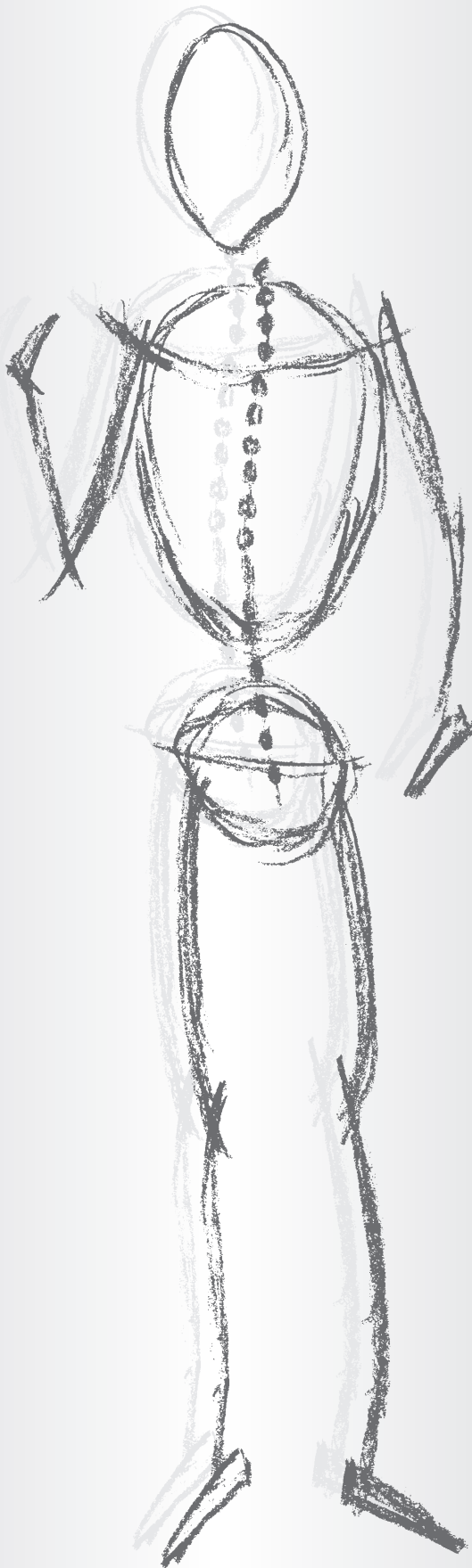

---

**OPTIKEN**

---

**TELESCOPES**

---

**ÓPTICAS**

---

**OTTICHE**



[www.Reda-Instrumente.de](http://www.Reda-Instrumente.de)

Cystoskope 302 mm Nutzlänge, integrierte Fiberoptik Faser für Beleuchtung, autoklavierbar  
Cystoscopes 302 mm working length, incorporated fiber optic bundle for illumination, autoclavable  
Cistoscopio 302 mm longitud, con conductor de luz de fibra, esterilizable e autoclavable  
Optica Cistoscopio lunghezza utile 302 mm a vision con conduttore di luce a fibre ottiche



Blickrichtung  
Angle of view  
Dirección visual  
Angolo di visione

Ø 4,0 mm

0°	<b>R300-040302-000</b>
15°	<b>R300-040302-015</b>
30°	<b>R300-040302-030</b>
70°	<b>R300-040302-070</b>



**Reda Instrumente GmbH**  
Gänsäcker 34 - P.O. Box 131  
D-78532 Tuttlingen

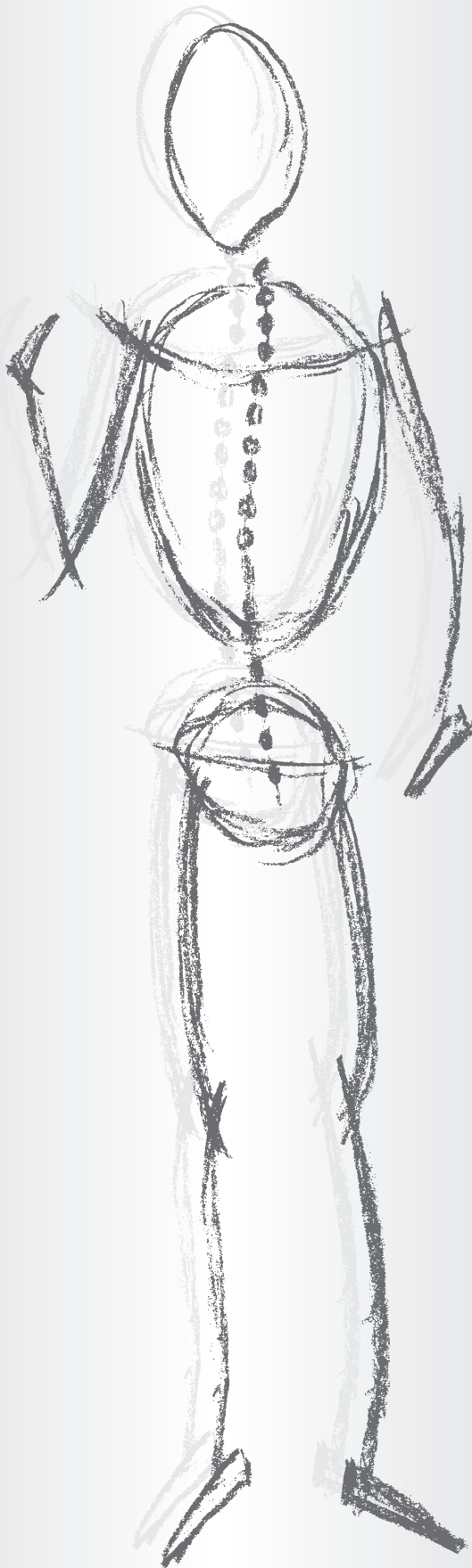

---

**CYSTOSKOPIE**

---

**CYSTOSCOPY**

---

**CISTOSCOPIÁ**

---

**CISTOSCOPIA**



[www.Reda-Instrumente.de](http://www.Reda-Instrumente.de)

Cystoskop-Schäfte, 2 Hähne fest mit LL-Adapter  
 Cystoscopy sheaths, 2 stop cocks fixed with LL-adapters  
 Camisas para cistoscopia, 2 valvas nigras adaptador de LL  
 Camicia per cistoscopia, 2 rubinetti fissi con adattatore LL

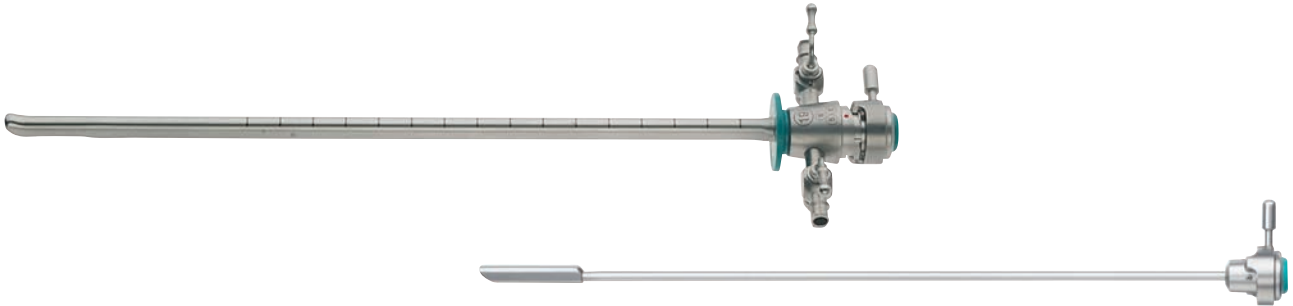

Ø [Char]	Obturator	Sheath	Sheath + Obturator	Colour Code
17	R310-170000-001	R310-170235-001	R311-170235-001	Yellow
19	R310-190000-001	R310-190235-001	R311-190235-001	Green
21	R310-210000-001	R310-210235-001	R311-210235-001	Red
23	R310-230000-001	R310-230235-001	R311-230235-001	Blue
25	R310-250000-001	R310-250235-001	R311-250235-001	White



	Ø [Char]	
Sichtobturator für Cystoskopschaft	17	R310-170000-003
Visual obturator for cystoscope sheath	19	R310-190000-003
Obturador visual para camisa de cistoscopia	21	R310-210000-003
Otturatore di visualizzazione	23	R310-230000-003
	25	R310-250000-003

Cystoskop-Schaft, Zentralhahn mit LL-Adapter  
Cystoscopy sheath, central valve fixed with LL-adapters  
Camisas para cistoscopio, valvula central con adaptador de LL  
Camicia cistoscopio, 2 rubinetti fissi dotato di rubinetto centrale con ingresso LL



<b>Ø [Char]</b>	<b>Obturator</b>	<b>Sheath</b>	<b>Sheath + Obturator</b>	<b>Colour Code</b>
17	R310-170000-001	R312-170235-001	R313-170235-001	Yellow
19	R310-190000-001	R312-190235-001	R313-190235-001	Green
21	R310-210000-001	R312-210235-001	R313-210235-001	Red
23	R310-230000-001	R312-230235-001	R313-230235-001	Blue
25	R310-250000-001	R312-250235-001	R313-250235-001	White

Cystoskopie - Optikbrücken Ø 4 mm  
Cystoscopy - Telescope bridges Ø 4 mm  
Cistoscopia - Puente para optica de Ø 4 mm  
Cistoscopio - Ponticello Ø 4 mm

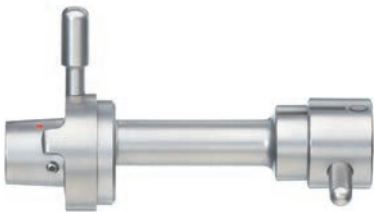
**R310-040000-000**

Optikbrücke für Diagnose  
Telescope bridge for diagnostic  
Puente para optica para el diagnostico  
Ponticello diagnostico per visione diretta

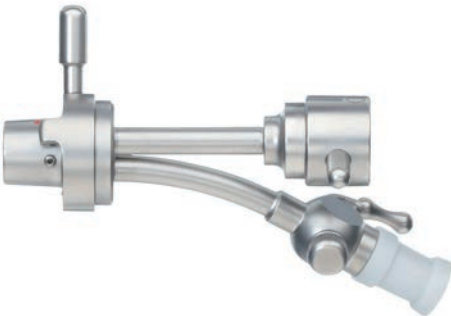
**R310-040000-001**

Optikbrücke mit 1 Instrumentenkanal verschließbar  
Telescope bridge with 1 instrument channel lockable  
Puente para optica con 1 canal obturable para instrumental  
Ponticello diagnostico con 1 ingresso

**R310-040000-002**

Optikbrücke mit 2 Instrumentenkanal verschließbar  
Telescope bridge with 2 instrument channel lockable  
Puente para optica, con 2 canales obturables para instrumental  
Ponticello diagnostico con 2 ingressi

Cystoskopie - Arbeitseinsatz mit Albarran-Lenkhebel  
 Cystoscopy - Working-element with Albarran deflector  
 Cistoscopia - vaina de trabajo con palanca conductor tipo Albarran  
 Cistoscopio - Inserto operativo con leva di ALBARRAN



1 Instrumentenkanal	W/O ratchet	W ratchet
1 instrument channel		
1 canal para instrumentos	<b>R310-040000-011</b>	<b>R310-040000-021</b>
1 canale per strumenti		

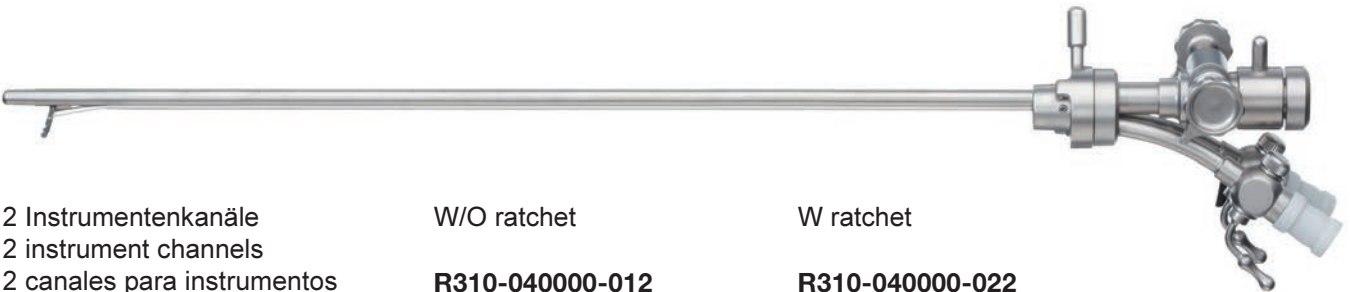

2 Instrumentenkanäle	W/O ratchet	W ratchet
2 instrument channels		
2 canales para instrumentos	<b>R310-040000-012</b>	<b>R310-040000-022</b>
2 canali per strumenti		



NICKELL Cystoskop Adapter für Frauen	<b>R319-900-01</b>
NICKELL cystoscope adapter for women	
NICKELL adaptador cistoscopico para mujeres	
NICKELL adattatore per donne	

Optische Instrumente für Cystoskopschäfte ab 21 Char Ø  
Optical instruments suitable for cystoscope sheath up on 21 Char Ø  
Instrumental optico para vainas cistoscópicas de 21 Char Ø  
Instrumenti ottici per camicia cistoscopica 21 Char Ø



Biopsiezange  
Biopsy forceps  
Pinza biopsia  
Pinza per biopsia

R315-021000-01



Biopsiestanze  
Biopsy punch  
Pinza biopsia  
Pinza tagliente per biopsia

R315-021000-06



Schere  
Scissor  
Tijera  
Forbici

R315-021000-021



Faßzange  
Grasping forceps  
Pinza de agarre  
Pinza per presa

R315-021000-011

Optische Instrumente für Cystoskopschäfte ab 21 Char Ø  
Optical instruments suitable for cystoscope sheath up on 21 Char Ø  
Instrumental optico para vainas cistoscopicas de 21 Char Ø  
Instrumenti ottici per camicia cistoscopica 21 Char Ø

Probeexzisionszange, optisch  
Biopsy punch, optical  
Pinza de biopsia, óptica  
Pinza per biopsia con canale per ottica



30° **R315-021000-30**

70° **R315-021000-70**

Adapter f. Resektoskop Schäfte  
Adaptor f. resectoscope sheath  
Adaptador para vainas resectoscopicas  
Adattatore per camicie resettoscopio





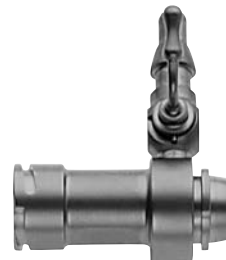



**R315-901**



**R315-902**







Flexible Instrumente 40 cm  
 Flexible instruments 40 cm  
 Instrumentos flexible 40 cm  
 Instrumenti Flessibili 40 cm

**Nutzlänge von 34 cm auf Anfrage erhältlich**  
**Length of 34 cm available on request**  
**Largo util de 34 cm disponible a petición**  
**Lunghezza utile 34 cm disponibile su richiesta**

	Ø 5 [Char]	Ø 6 [Char]	Ø 7 [Char]	Ø 9 [Char]
 <p>Biopsiezange            Bopsy forceps            Pinza de biopsia            Pinza per biopsia con            doppia articolazione</p>	R392-017400-001	R392-021400-001	R392-023400-001	R392-030400-001
 <p>Löffel gezahnt            Foreign body, short            Cuchara dentada            Pinza per la rimozione con            doppia articolazione</p>	R392-017400-003	R392-021400-003	R392-023400-003	R392-030400-003
 <p>Biopsiezange einfachbeweglich            Bopsy punch single action            Pinza para biopsia articulacion            simple            Pinza per biopsia mono articolata</p>			R392-023400-004	
 <p>Löffel oval            Spoon Forceps            Cuchara oval            Cucchiaino ovale con            denti aggressivi</p>	R392-017400-005	R392-021400-005	R392-023400-005	
 <p>Fasszange            Grasping forceps            Pinza de agarre            Pinza da presa            con doppia articolazione</p>		R392-021400-006		
 <p>Fremdkörperzange            Foreign body forceps            Pinza para cuerpos extraños            Pinza da presa per corpi            estranei, mono articolata</p>			R392-023400-009	



**Nutzlänge von 34 cm auf Anfrage erhältlich**  
**Length of 34 cm available on request**  
**Largo util de 34 cm disponible a petición**  
**Lunghezza utile 34 cm disponibile su richiesta**

	Ø 5 [Char]	Ø 6 [Char]	Ø 7 [Char]	Ø 9 [Char]
 <p>Fremdkörper-Zange Foreign body forceps Pinza para cuerpos extraños Pinza da presa per corpi estranei con doppia articolazione</p>			R392-023400-010	
 <p>Alligatorfaßzange Alligator grasping forceps Pinza de agarre tipo caiman Pinza da presa tipo alligator con doppia articolazione</p>	R392-017400-011	R392-021400-011	R392-023400-011	R392-030400-011
 <p>Steinzange Stone grasping forceps Pinza para calculus Pinza da presa per calculi con doppia articolazione</p>			R392-023400-014	
 <p>Schere Scissor Tijera Forbici mono articolata</p>	R392-017400-021	R392-021400-021	R392-023400-021	R392-030400-021
 <p>Schere doppelt beweglich Scissor, double action Tijera, articulacion doble Forbici con doppia articolazione, lama seghettata</p>			R392-023400-022	
 <p>Hakenschere Hook scissor Tijera en forma de gancho Forbici rette uncinata mono articolate</p>			R392-023400-023	R392-030400-023

Dormia Steinfänger  
Dormia stone dislodger  
Malla para rescadar calculus  
Cestello dormia

**R394-017600-004**

4 Drähte, 5 Char Ø, 600 mm Nutzlänge  
4 wires, 5 Fr. Ø, 600 mm work.length  
Extractor de calculus de 4 alambres 5 Char Ø, 600 mm de largo util  
Cestello dormia 4 filamenti, lunghezza 600 mm



**R394-017600-006**

6 Drähte, 5 Char Ø, 600 mm Nutzlänge  
6 wires, 5 Fr. Ø, 600 mm work.length  
Extractor de calculus de 6 alambres 5 Char Ø, 600 mm de largo util  
Cestello dormia 6 filamenti, lunghezza 600 mm

**R394-000000-000**

Griff für Dormia Steinfänger  
handle for Dormia stone dislodger  
mango para Malla para rescadar calculus  
Impugnatura per Cestello dormia

Koagulationselektroden, flexibel  
 Coagulation electrodes, flexible  
 Electrodo para coagulación, flexible  
 Elettrodo per coagulazione, flessibile

	Ø 3 [Char]	Ø 5 [Char]	Ø 7 [Char]	Ø 9 [Char]
 <p>Knopf Ball end Bola Sfera</p>	R395-010450-001	R395-017450-001	R395-023450-001	R395-030450-001
 <p>Nadel Needle type Aguja Ago</p>	R395-010450-021	R395-017450-021	R395-023450-021	
 <p>Schlinge Loop Asa Ansa</p>		R395-017450-011	R395-023450-011	R395-030450-011

Polypektomie-Schlinge  
 Polypectomy loop  
 Asa para polipectomia  
 Ansa per polipectomia



Ø 5 [Char]  
 R395-017400-125

Ø 7 [Char]  
 R395-023400-125

Handgriff mit HF Anschluß für Diathermie Schlinge  
 Handle w. HF connector for diathermy loop  
 Mango con conexión de alta frecuencia para asa de diatermia  
 Impugnatura per dormia con cursore ad anello dotata di attacco monopolare



R395-000000-000

Lithotripsie  
Lithotripsy  
Litotripsia  
Litotripsia

**R315-250000-39** (for 25 Char)

Steinzange  
Stone grasping forceps  
Pinza para cálculo  
Pinza per calcoli

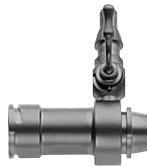
**R315-902**

Adapter für Steinzange  
Adapter for grasping forceps  
Adaptador para el uso de la pinza para cálculo  
Adattore con rubinetto per l'uso delle pinze per calcoli

**R315-240000-59**

Arbeitselement zur Stanz-Lithotripsie; optisch, 24 Char  
Working element for punch lithotripsy; optical, 24 Fr.  
Element de trabajo para litotripsia; óptico, 24 Char  
Strumento ottico, 24 Char di lavoro operativo per litotripsia

**R313-240235-001**

Lithotripsie Schaft mit Zentralhahn 24 Char  
Lithotripsy sheath with central valve, 24 Fr.  
Vaina para litotripsia con llave central, 24 Char  
Camicia per litotripsia con rubinetto centrale, 24 Char

**R310-240000-001**

Obturator Standard; für Lithotripsie Schaft 24 Char  
Obturator standard; for lithotripsy sheath 24 Fr.  
Obturator estándar; para vaina de litotripsiá 24 Char  
Otturatore standard; per camicia litotriptisia 24 Char

**R312-240000-001**

Optikbrücke mit 1 Instrumentenkanal 24 Char  
Telescope bridge; 1 instrument channel 24 Fr.  
Puente óptico; 1 canal para instrumentos 24 Char  
Ponte per telescopio con 1 canale per strumenti 24 Char

**Reda Instrumente GmbH**  
Gänsäcker 34 - P.O. Box 131  
D-78532 Tuttlingen

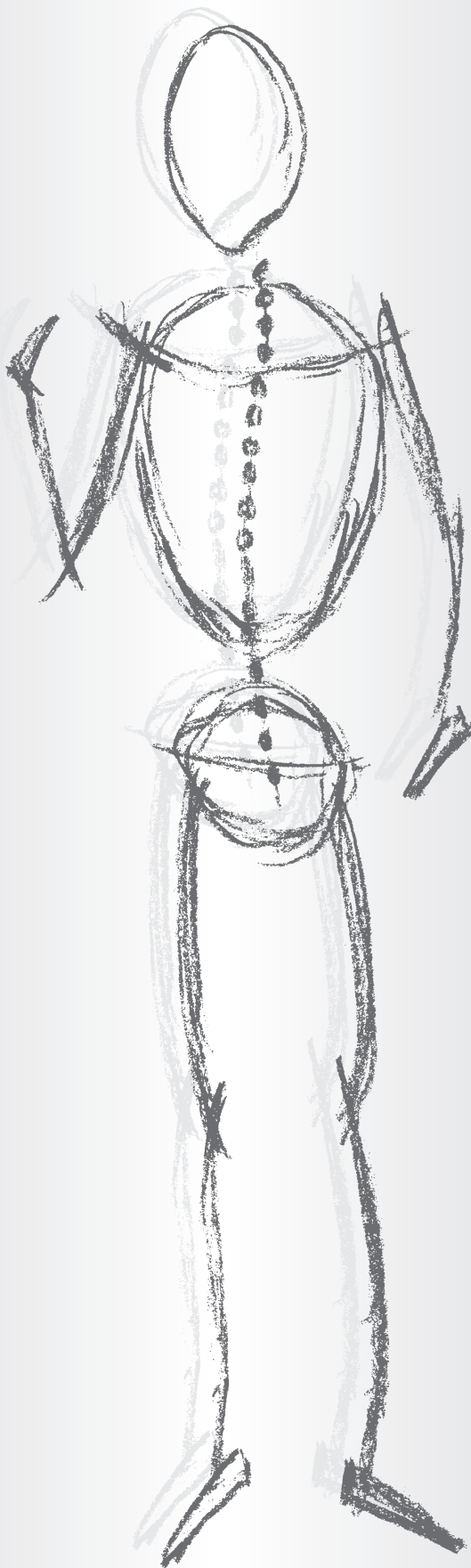

---

**RESEKTOSKOPIE**

---

**RESECTOSCOPY**

---

**RESECTOSCOPIÁ**

---

**RESECTOSCOPIA**



[www.Red-Instrumente.de](http://www.Red-Instrumente.de)

Arbeitselement für Ø 4 mm Optik  
Working element for Ø 4 mm optic  
Elemento de trabajo para óptica Ø 4 mm  
Elemento di lavoro per l'uso con ottica Ø 4 mm

"AKTIV", schneidend durch Fingerdruck  
"ACTIVE", cutting by finger action  
"ACTIVO", cortante por la presión del dedo  
Impugnatura con movimento "ATTIVO"

**R320-040225-11**

Griff geschlossen  
Closed handle  
Mango cerrado  
Manico con anello chiuso

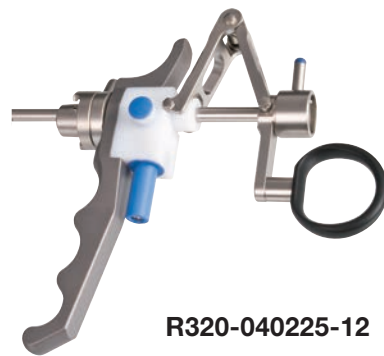
**R320-040225-12**

Griff offen  
Opened handle  
Mango abierto  
Manico aperto

Arbeitselement "PASSIV", schneiden durch Federzug  
Working element "PASSIVE", cutting by spring action  
Elemento de trabajo "PASSIVO", cortante por balancin  
Elemento di lavoro con movimento "PASSIVO"

**R320-040225-01**

Griff geschlossen  
Closed handle  
Mango cerrado  
Manico con anello chiuso

**R320-040225-02**

Griff offen  
Opened handle  
Mango abierto  
Manico aperto

Hochfrequenzkabel, monopolar, für Geräte von:  
High frequency cable, monopolar, for devices of:  
Cable monopolar de alta frecuencia, para equipos de:  
Cavo monopolare ad alta frequenza per apparecchi:



4 mm

Eschmann alte Gerät, Erbe T-Serie old units  
R329-040000-003 3 mtr.  
R329-040000-005 5 mtr.



4 mm

Aesculap, Berchtold, Martin  
R329-040000-203 3 mtr.  
R329-040000-205 5 mtr.



5 mm

Erbe, Storz  
R329-050000-003 3 mtr.  
R329-050000-005 5 mtr.



8 mm

Valleylab  
R329-080000-003 3 mtr.  
R329-080000-005 5 mtr.

Dauerspül Resektoskop-Schäfte  
 Resectoscope sheats, continuous flow  
 Vaina para resectoscopio con flujo continuo  
 Camicia resettore, a aspirazione continua



Innenschaft, ohne Spülhahn mit LL-Adapter  
 Inner Sheat, without irrigation stop cock with LL-adapter  
 Vaina interior, valvula de irrigacion sin adaptador de LL  
 Camicia interna, attacco LL senza rubinetto fisso

Ø [Char]

24	Drehbar Rotatable rotabile	<b>R320-240000-130</b>
	Nicht drehbar Not rotatable non rotabile	<b>R320-240000-030</b>
27	Drehbar Rotatable rotabile	<b>R320-270000-130</b>
	Nicht drehbar Not rotatable non rotabile	<b>R320-270000-030</b>

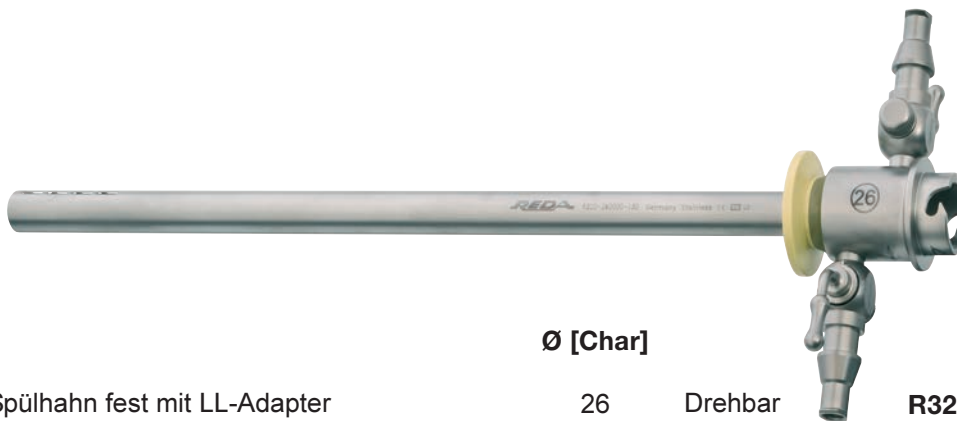

Außenschaft, 2 Spülhahn fest mit LL-Adapter  
 Outer Sheat, 2 irrigation stop cock with LL-adapter  
 Vaina exterior, 2 valvula de irrigacion con adaptador de LL  
 Camicia esterna, attacco LL con 2 rubinetti fissi

Ø [Char]

26	Drehbar Rotatable rotabile	<b>R320-260000-130</b>
	Nicht drehbar Not rotatable non rotabile	<b>R320-260000-030</b>
28,5	Drehbar Rotatable rotabile	<b>R320-285000-130</b>
	Nicht drehbar Not rotatable non rotabile	<b>R320-285000-030</b>



Dauerspül Resektoskop-Schäfte  
 Resectoscope sheats, continuous flow  
 Vaina para resectoscopio con flujo continuo  
 Camicia resettore, a aspirazione continua



**Ø [Char]**

Kombinierte Schäfte  
 Combi sheats  
 Vainas combinadas  
 Camicia con combinazione

24 / 26	Drehbar Rotatable rotabile	<b>R320-260240-130</b>
	Nicht drehbar Not rotatable non rotabile	<b>R320-260240-030</b>
27 / 28,5	Drehbar Rotatable rotabile	<b>R320-285270-130</b>
	Nicht drehbar Not rotatable non rotabile	<b>R320-285270-030</b>

Resektoskopie Obturatoren  
 Resectoscopy obturators  
 Obturador para resectoscopia  
 Otturatori per resettoscopia







Standard Obturator	Ø [Char]	
Standard obturators	24	R320-240000-001
Obturador estandar	27	R320-270000-001
Standard otturatore		







Obturator, krümmbar	Ø [Char]	
Obturator deflectable	24	R320 240000-002
Obturador flexible	27	R320-270000-002
Otturatore mono aticolato		



Sicht-Obturatot	Ø [Char]		
Visual Obturator	24	ohne Kanal without channel sin canal	R320-240000-003
Obturador visual		mit Kanal with channel con canal	R320-240000-005
Otturatore diagnostico per visualizzazione diretta			
	27	ohne Kanal without channel sin canal	R320-270000-003
		mit Kanal with channel con canal	R320-270000-005

		<b>Ø 24 [Char]</b>	<b>Ø 27 [Char]</b>
	Schlinge retrograde gebogen Loop, retrograde curved Electrodo de asa, curva retrogradamente Ansa per taglio, angolata	<b>R329-240000-001</b> (for 0° Optic) <b>R329-240030-001</b> (for 30° Optic)	<b>R329-270000-001</b> (for 0° Optic) <b>R329-270030-001</b> (for 30° Optic)
	Schlinge gerade Loop, straight Asa recta Ansa per taglio, ad asso longitudinale	<b>R329-240010-001</b>	<b>R329-270010-001</b>
	Kugel Ball Bola sferico	<b>R329-240040-003</b> (Ø 3 mm) <b>R329-240040-005</b> (Ø 5 mm)	<b>R329-270040-003</b> (Ø 3 mm) <b>R329-270040-005</b> (Ø 5 mm)
	Rolle Roller barrel Rollo Rullo	<b>R329-240050-003</b> (Ø 3 mm) <b>R329-240050-005</b> (Ø 5 mm)	<b>R329-270050-003</b> (Ø 3 mm) <b>R329-270050-005</b> (Ø 5 mm)
	Vaporisationsschlinge Vaporisation Loop Asa de vaporisacion Elettrodo per vaporizzazione	<b>R329-240055-001</b> (for 0° Optic) <b>R329-240056-001</b> (for 30° Optic)	<b>R329-270055-001</b> (for 0° Optic)

Monopolare Elektroden  
 Monopolar electrodes  
 Electrodo monopolar  
 Elettrodo monopolare

		Ø 24 [Char]	Ø 27 [Char]
	Vaporisationselektrode	<b>R329-240052-003</b>	<b>R329-270052-003</b>
	Vaporisation electrode	(Ø 3 mm)	(Ø 3 mm)
	Electrodo de vaporisation	<b>R329-240052-005</b>	<b>R329-270052-005</b>
	Elettrodo a rullo per vaporizzazione	(Ø 5 mm)	(Ø 5 mm)
	Spike	<b>R329-240054-003</b>	
	Spike electrode	(Ø 3 mm)	
	Electrodo de Spike	<b>R329-240054-005</b>	
	Elettrodo di Spike	(Ø 5 mm)	
	Kegel	<b>R329-240090-003</b>	
	Cone		
	Cono		
	Conico		
	Messer	<b>R329-240070-001</b>	<b>R329-270070-001</b>
	Knife		
	Cuchillo		
	Elettrodo di coagulazione a bisturi		

**R329-990**



Sterilisierhülse für Elektroden  
 Sterilization tube for electrodes  
 Embudo para esterilizacion de electrodos  
 Tubo di protezione per elettrodi

**Reda Instrumente GmbH**  
Gänsäcker 34 - P.O. Box 131  
D-78532 Tuttlingen

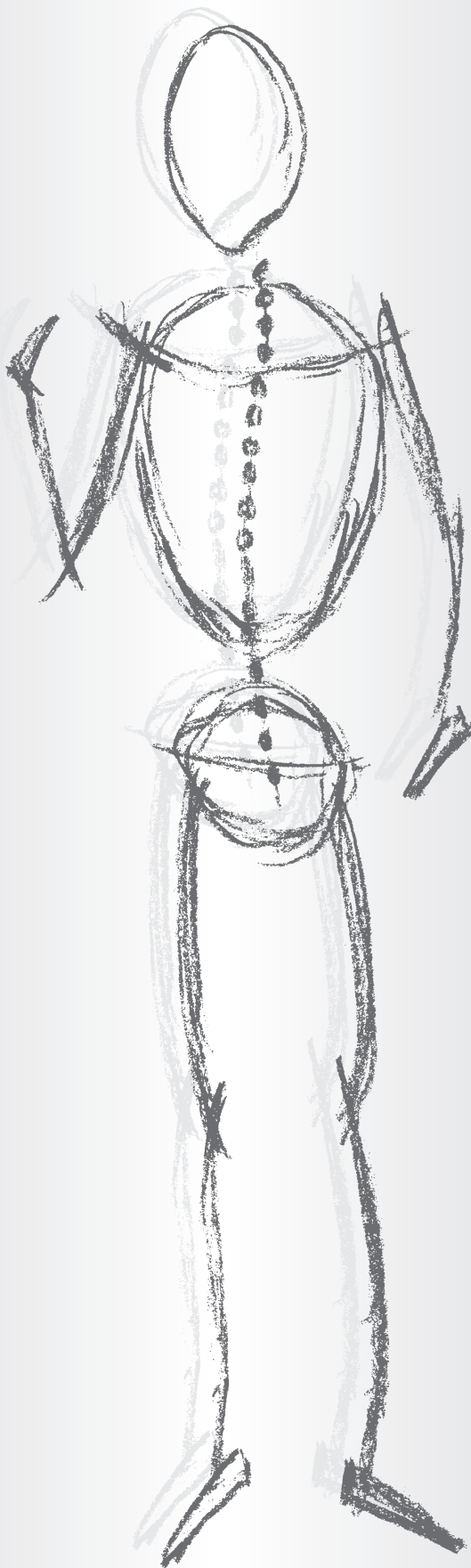

---

**URETHROTOM**

---

**URETHROTOME**

---

**URETRÓTOMO**

---

**URETROTOMO**



[www.Reda-Instrumente.de](http://www.Reda-Instrumente.de)

Urethrotomie  
Urethrotomy  
Uretrotomia  
Uretrotomia

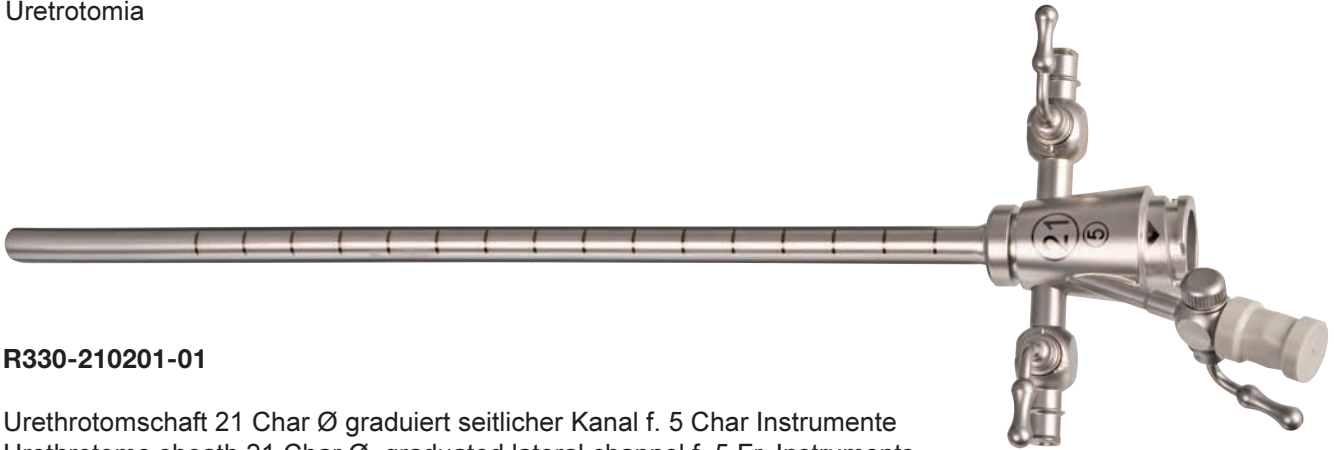
**R330-210201-01**

Urethrotomschaft 21 Char Ø graduiert seitlicher Kanal f. 5 Char Instrumente  
Urethrotome sheath 21 Char Ø, graduated lateral channel f. 5 Fr. Instruments  
Vaina para uretrotomo de 21 Char Ø con canal graduado lateral para instrumentos de 5 Char  
Camicia per uretrotomo 21 Char Ø

**R330-230201-001**

Zusatzschaft für Urethrotom, seitlich offen  
Supplementary sleeve, lateral open  
Vaina adicional para uretrotomo, apertura lateral  
Camicia supplementare, aperta lateralmente

**R330-230201-102**

Dauerspül Zusatzschaft für Urethrotomschaft 21 Char Ø  
Continuous Flow supplementary sleeve for urethrotom-sleeve 21 Char Ø  
Vaina adicional para irrigación continua para uretrotomo de 21 Char Ø  
Camicia supplementare a lavaggio continuo 21 Char Ø per camicia per uretrotomo



**R330-210000-01**

Urethrotom Standard Obturator für 21 Char Ø Schaft #R330-210201-01  
Urethrotome standard obturator for 21 Char Ø sheath #R330-210201-01  
Obturador estándar para uretrótomo de 21 Char Ø vaina #R330-210201-01  
Otturatore, per camicia per uretrotomo, 21 Char Ø #R330-210201-01



**R330-210000-11**

Urethrotom Standard Obturator für 21 Char Ø mit Arbeitskanal  
Urethrotome standard obturator for 21 Char Ø with instrument channel  
Obturador estándar para uretrótomo de 21 Char Ø con 1 canal para instrumentos  
Otturatore, per camicia per uretrotomo, 21 Char con 1 canale operative per strumenti

**R339-040000-001**

Optikbrücke  
Telescope bridge  
Puente para optica  
Ponticello per uretrotomo

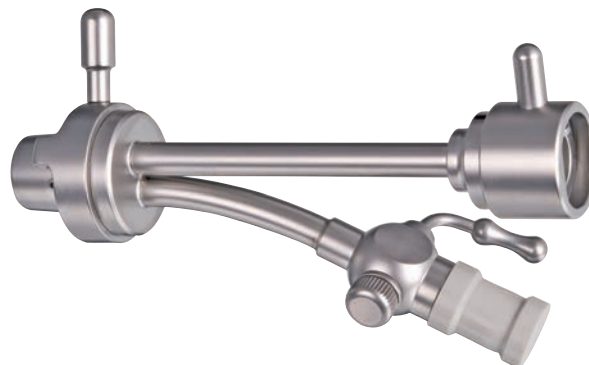

Strikturmesser  
Cold knife  
Cuchillo de corte frio  
Lama uretrotomo per taglio a freddo



**R339-210000-001**  
gerade  
straight  
recto  
retto



**R339-210000-002**  
Wellenschliff  
wave shaped  
filo ondulado  
affilatura ondulata



**R339-210000-011**  
rund  
round shaped  
semicircular  
semisferico



**R339-210000-021**  
ringförmig  
ring shaped  
en forma de anillo  
ad anello



**R339-210000-031**  
sichelförmig  
sickle shaped  
en forma de hoz  
ad uncino



**Reda Instrumente GmbH**  
Gänsäcker 34 - P.O. Box 131  
D-78532 Tuttlingen

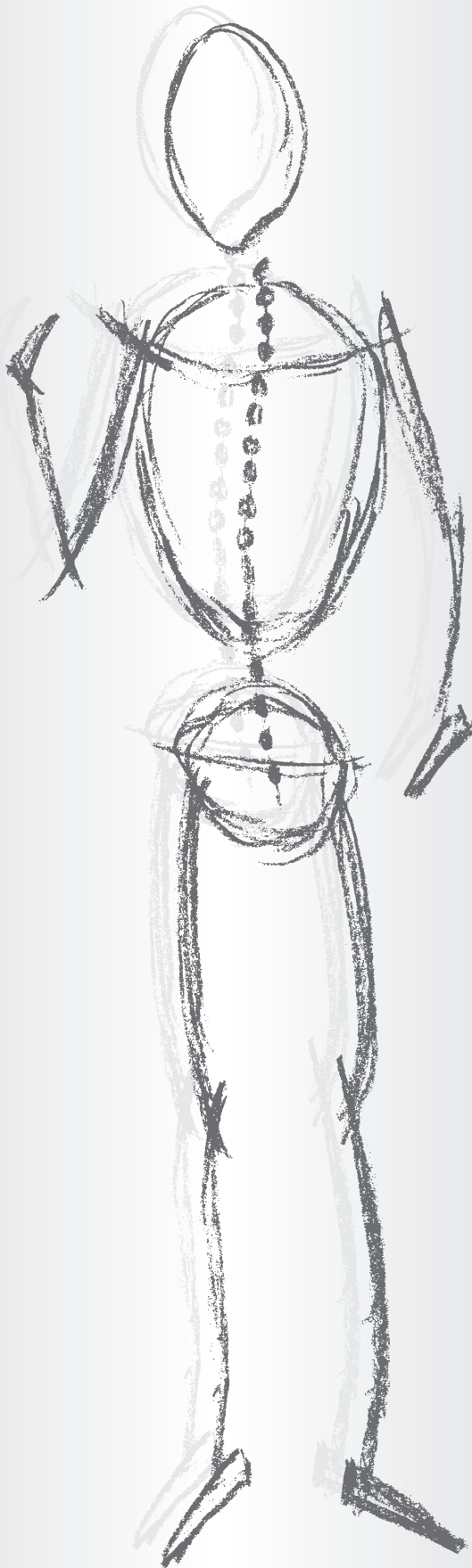

**CYSTOSKOPIE**  
für 2,9 mm Ø Optik

**CYSTOSCOPY**  
for 2,9 mm Ø optic

**CISTOSCOPIÁ**  
para óptica 2,9 mm Ø

**CISTOSCOPIA**  
per ottica 2,9 mm Ø



[www.Reda-Instrumente.de](http://www.Reda-Instrumente.de)

Cystoskope 302 mm Nutzlänge, integrierte Fiberoptik Faser für Beleuchtung, autoklavierbar  
Cystoscopes 302 mm working length, incorporated fiber optic bundle for illumination, autoclavable  
Cistoscopio 302 mm longitud, con conductor de luz de fibra, esterilizable e autoclavable  
Cistoscopio lunghezza utile 302 mm, con conduttore di luce a fibre ottiche sterilizzabile in autoclave



Blickrichtung  
Angle of view  
Dirección visual  
Angolo di visione

Ø 2,9 mm

0°	<b>R300-029302-000</b>
15°	<b>R300-029302-015</b>
30°	<b>R300-029302-030</b>
70°	<b>R300-029302-070</b>

Cystoskop-Schäfte  
Cystoscopy sheaths  
Camisas para cistoscopia  
Camicie per cistoscopia



Ø [Char] 15

Cystoskop-Schaft, 2 Hähne fest mit LL-Adapter  
Cystoscopy sheath, 2 stop cocks fixed with LL-adapters  
Camisa para cistoscopia, 2 valvulas con adaptador de LL  
Camicia cistoscopia, 2 rubinetti fissi incluso, 2 coni LL

Obturator	<b>R310-150000-001</b>
Sheath + Obturator	<b>R310-150235-001</b>
Sheath	<b>R311-150235-001</b>

Cystoskopie - Optikbrücken  
Cystoscopy - Telescope bridges  
Cistoscopia - Puente para optica  
Cistoscopio - Ponticello

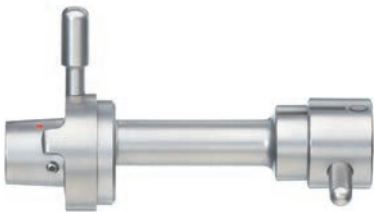
**R310-029000-000**

Optikbrücke für Diagnose  
Telescope bridge for diagnostic  
Puente para optica para el diagnostico  
Ponticello diagnostico per visione diretta

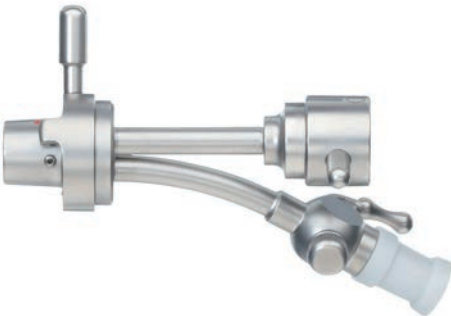
**R310-029000-001**

Optikbrücke mit 1 Instrumentenkanal verschließbar  
Telescope bridge with 1 instrument channel lockable  
Puente para optica con 1 canal obturable para instrumental  
Ponticello diagnostico con 1 canale

**R310-029000-002**

Optikbrücke mit 2 Instrumentenkanal verschließbar  
Telescope bridge with 2 instrument channel lockable  
Puente para optica con 2 canales obturables para instrumental  
Ponticello diagnostico con 2 canali

Cystoskopie - Arbeitseinsatz mit Albarran-Lenkhebel  
Cystoscopy - Working-element with Albarran deflector  
Cistoscopia - vaina de trabajo con palanca conductor tipo Albarran  
Cistoscopio - Inserto operativo con leva di ALBARRAN



**R310-029000-011**

Arbeitseinsatz mit Albarran-Lenkhebel, 1 Instrumentenkanal  
Working-element with Albarran deflector, 1 instrument channel  
Vaina de trabajo con palanca conductora tipo Albarran, 1 canal para instrumental  
Inserto operativo con leva di ALBARRAN con 1 ingresso







**R310-029000-012**

Arbeitseinsatz mit Albarran-Lenkhebel, 2 Instrumentenkanäle  
Working-element with Albarran deflector, 2 instrument channels  
Vaina de trabajo con palanca conductora tipo Albarran, 2 canales para instrumental  
Inserto operativo con leva di ALBARRAN con 2 ingressi

Flexible Instrumente 40 cm  
 Flexible instruments 40 cm  
 Instrumentos flexible 40 cm  
 Instrumenti Flessibili 40 cm

**Nutzlänge von 34 cm auf Anfrage erhältlich**  
**Length of 34 cm available on request**  
**Largo util de 34 cm disponible a petición**  
**Lunghezza utile 34 cm disponibile su richiesta**

	Ø 5 [Char]	Ø 4 [Char]	Ø 3,5 [Char]	Ø 3 [Char]
 <p>Biopsiezange                      Biopsy forceps                      Pinza de biopsia                      Pinza per biopsia con                      doppia articolazione</p>	R392-017400-001	R392-014400-001	R392-012400-001	R392-010400-001
 <p>Löffel oval                      Spoon Forceps                      Cuchara oval                      Cucchiaino ovale con                      denti aggressivi</p>	R392-017400-005			R392-010400-005
 <p>Alligatorfaßzange                      Alligator grasping forceps                      Pinza de agarre tipo caiman                      Pinza da presa tipo alligator con                      doppia articolazione</p>	R392-017400-011	R392-014400-011	R392-012400-011	R392-010400-011
 <p>Schere                      Scissor                      Tijera                      Forbici mono articolata</p>	R392-017400-021	R392-014400-021	R392-012400-021	R392-010400-021

**Reda Instrumente GmbH**  
Gänsäcker 34 - P.O. Box 131  
D-78532 Tuttlingen

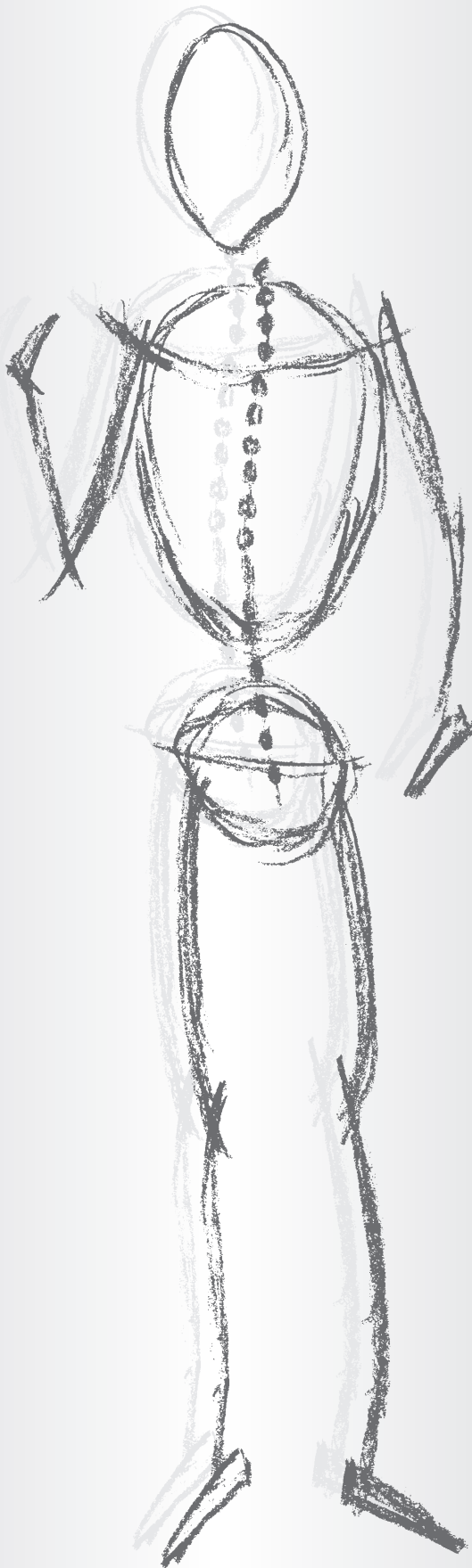

**RESEKTOSKOPIE**  
für 2,9 mm Ø Optik

**RESECTOSCOPY**  
for 2,9 mm Ø optic

**RESECTOSCOPIA**  
para óptica 2,9 mm Ø

**RESECTOSCOPIA**  
per ottica 2,9 mm Ø



[www.Reda-Instrumente.de](http://www.Reda-Instrumente.de)

Arbeitselement für Ø 2,9 mm Optik  
Working element for Ø 2,9 mm optic  
Vaina de trabajo para óptica de Ø 2,9 mm  
Elemento di lavoro per ottico Ø 2,9 mm

"AKTIV", schneidend durch Fingerdruck  
"ACTIVE", cutting by finger action  
"ACTIVO", cortante por la presión del dedo  
impugnatura con movimento "ATTIVO"

**R320-027225-11**

Griff geschlossen  
Closed handle  
Mango cerrado  
Manico con anello chiuso

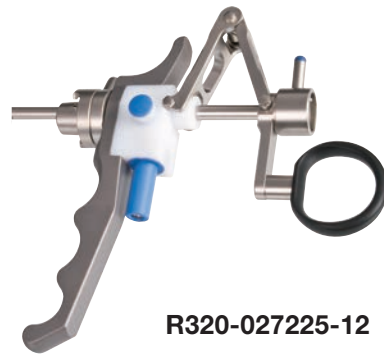
**R320-027225-12**

Griff offen  
Opened handle  
Mango abierto  
Manico aperto

Arbeitselement "PASSIV", schneiden durch Federzug  
Working element "PASSIVE", cutting by spring action  
Elemento de trabajo "PASSIVO", cortante por balancin  
Elemento di lavoro con movimento "PASSIVO"

**R320-027225-01**

Griff geschlossen  
Closed handle  
Mango cerrado  
Manico con anello chiuso

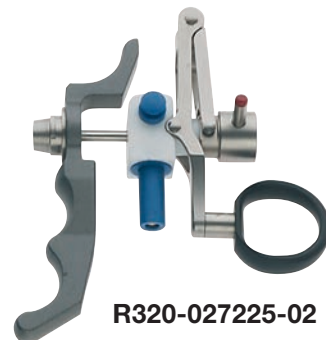
**R320-027225-02**

Griff offen  
Opened handle  
Mango abierto  
Manico aperto



Hochfrequenzkabel, monopolar, für Geräte von:  
High frequency cable, monopolar, for devices of:  
Cable monopolar de alta frecuencia, para equipos de:  
Cavo monopolare ad alta frequenza per apparecchi:



4 mm

Eschmann alte Gerät, Erbe T-Serie old units  
**R329-040000-003** 3 mtr.  
**R329-040000-005** 5 mtr.



4 mm

Aesculap, Berchtold, Martin  
**R329-040000-203** 3 mtr.  
**R329-040000-205** 5 mtr.



5 mm

Erbe, Storz  
**R329-050000-003** 3 mtr.  
**R329-050000-005** 5 mtr.



8 mm

Valleylab  
**R329-080000-003** 3 mtr.  
**R329-080000-005** 5 mtr.

Dauerspül Resektoskop-Schäfte  
Resectoscope sheats, continuous flow  
Vaina para resectoscopio con flujo continuo  
Camicia resettore, a aspirazione continua

**Ø [Char]**

Innenschaft, 1 Spülhahn fest mit LL-Adapter  
Inner Sheat, 1 irrigation stop cock with LL-adapter  
Vaina interior, 1 valvula de irrigacion rigida con adaptador de LL  
Camicia interna, con 1 Rubinetto ingresso LL

19

Drehbar  
Rotatable  
rotable

**R320-190000-130**

Nicht drehbar  
Not rotatable  
non rotabile

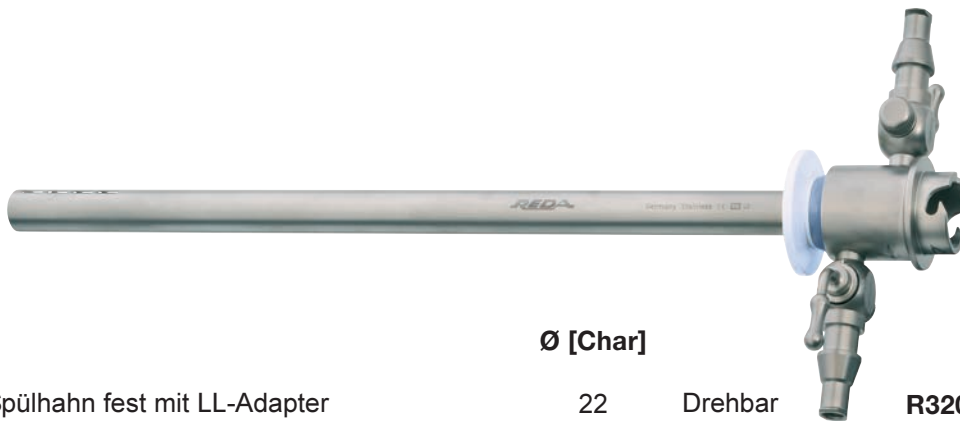
**R320-190000-030****Ø [Char]**

Außenschaft, 1 Spülhahn fest mit LL-Adapter  
Outer Sheat, 1 irrigation stop cock with LL-adapter  
Vaina exterior, 1 valvula de irrigacion rigida con adaptador de LL  
Camicia esterna, con 1 rubinetto ingresso LL

22

Drehbar  
Rotatable  
rotable

**R320-220000-130**

Nicht drehbar  
Not rotatable  
non rotabile

**R320-220000-030**

Dauerspül Resektoskop-Schäfte  
 Resectoscope sheats, continuous flow  
 Vaina para resectoscopia con flujo continuo  
 Camicia resettore, a aspirazione continua



Ø [Char]

Kombinierte Schäfte  
 Combi sheats  
 Vainas combinadas  
 Camicia con combinazione

19 / 22

Drehbar  
 Rotatable  
 rotabile

**R320-220190-130**

Nicht drehbar  
 Not rotatable  
 non rotabile

**R320-220190-030**

Resektoskopie Obturatoren  
Resectoscopy obturators  
Obturadores para resectoscopia  
Otturatori per resettoscopia



Standard Obturator  
Standard obturators  
Obturador estandar  
Standard otturatore

Ø [Char]  
19

R320-190000-001



Sicht-Obturator  
Visual Obturator  
Obturador visual  
Otturatore diagnostico per visualizzazione diretta

Ø [Char]  
19

ohne Kanal  
without channel  
sin canal

R320-190000-003

Monopolare Elektroden  
Monopolar electrodes  
Electrodos monopolares  
Elettrodo monopolare

**Ø 19 [Char]**



Schlinge retrograde gebogen  
Loop, retrograde curved  
Asa, curva retrogradamente  
Ansa per taglio, angolata

**R329-190000-001**  
(for 0° Optic)  
**R329-190030-001**  
(for 12° Optic)



Kugel  
Ball  
Bola  
Sferico

**R329-190040-002**  
(Ø 2 mm)  
**R329-190040-003**  
(Ø 3 mm)



Rolle  
Roller barrel  
Rollo  
Rullo

**R329-190050-003**  
(Ø 3 mm)



Messer  
Knife  
Cuchillo  
Elettrodo di coagulazione a bisturi

**R329-190070-001**



INSTRUMENTE GMBH

---

**Reda Instrumente GmbH**  
Gänsäcker 34 - P.O. Box 131  
D-78532 Tuttlingen

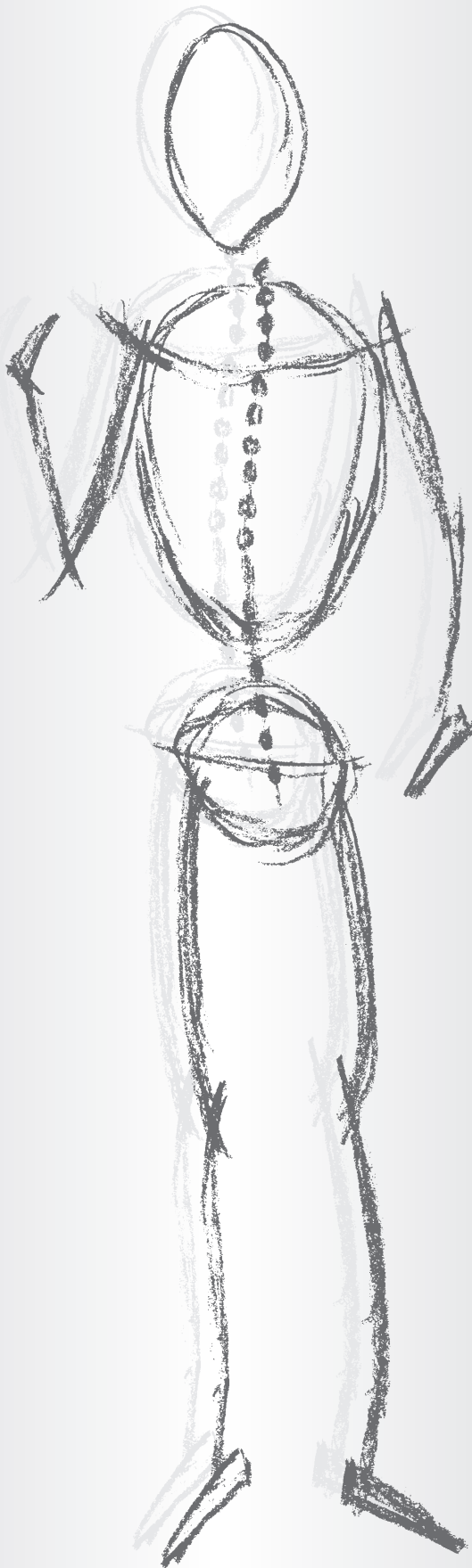

---

**URETHROTOMIE**

für 2,9 mm Ø Optik

---

**URETHROTOMY**

for 2,9 mm Ø optic

---

**URETRÓTOMO**

para óptica 2,9 mm Ø

---

**URETROTOMO**

per ottica 2,9 mm Ø



[www.Reda-Instrumente.de](http://www.Reda-Instrumente.de)

Urethrotomie  
Urethrotomy  
Uretrotomia  
Uretrotomia

**R330-155201-01**

Urethrotomschaft 15,5 Char Ø graduiert seitlicher Kanal f. 3 Char Instrumente  
Urethrotome sheath 15,5 Char Ø, graduated lateral channel f. 3 Fr. Instruments  
Vaina para uretrotomo de 15,5 Char Ø con canal graduado lateral para instrumentos de 3. Char  
Camicia per uretrotomo 15,5 Char Ø con scale graduate dotato di canale operativo

**R330-155201-102**

Zusatzschaft für Urethrotomschaft 15,5 Char Ø, seitlich offen  
Supplementary sleeve for urethrotom-sleeve 15,5 Char Ø, lateral open  
Vaina adicional para uretrótomo de 15,5 Char Ø, apertura lateral  
Camicia supplementare per uretrotomo 15,5 Char Ø, aperta laterale





**R330-155000-11**

Urethrotom Standard Obturator für 15,5 Char Ø Schaft R330-155201-01  
Urethrotome standard obturator for 15,5 Char Ø sheath R330-155201-01  
Obturador estándar para uretrótomo de 15,5 Char Ø vaina R330-155201-01  
Otturatore per camicia per uretrotomo 15,5 Char Ø R330-155201-01

**R339-029000-001**

Optikbrücke mit 3 Char Ø Arbeitskanal  
Telescope bridge w. 3 Char Ø working channel  
Puente para optica con canal de trabajo de 3 Char Ø  
Ponticello uretrotomo per strumenti 3 Char Ø

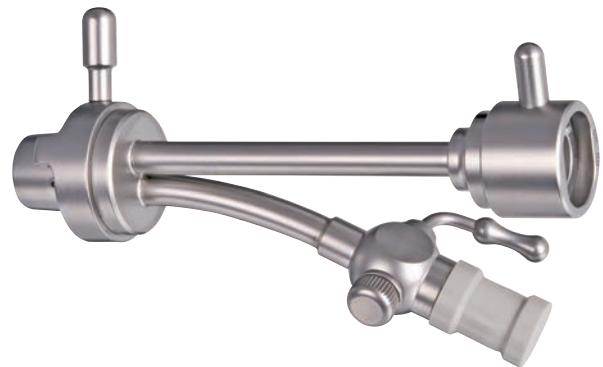

Strikturmesser  
Cold knife  
Cuchillo de corte frio  
Lama uretrotomo per taglio a freddo



**R339-155000-001**  
gerade  
straight  
recto  
retto



**R339-155000-002**  
Wellenschliff  
wave shaped  
filo ondulado  
affilatura ondulata



**R339-155000-011**  
rund  
round shaped  
semicircular  
semisferico



**R339-155000-031**  
sichelförmig  
sickle shaped  
en forma de hoz  
ad uncino

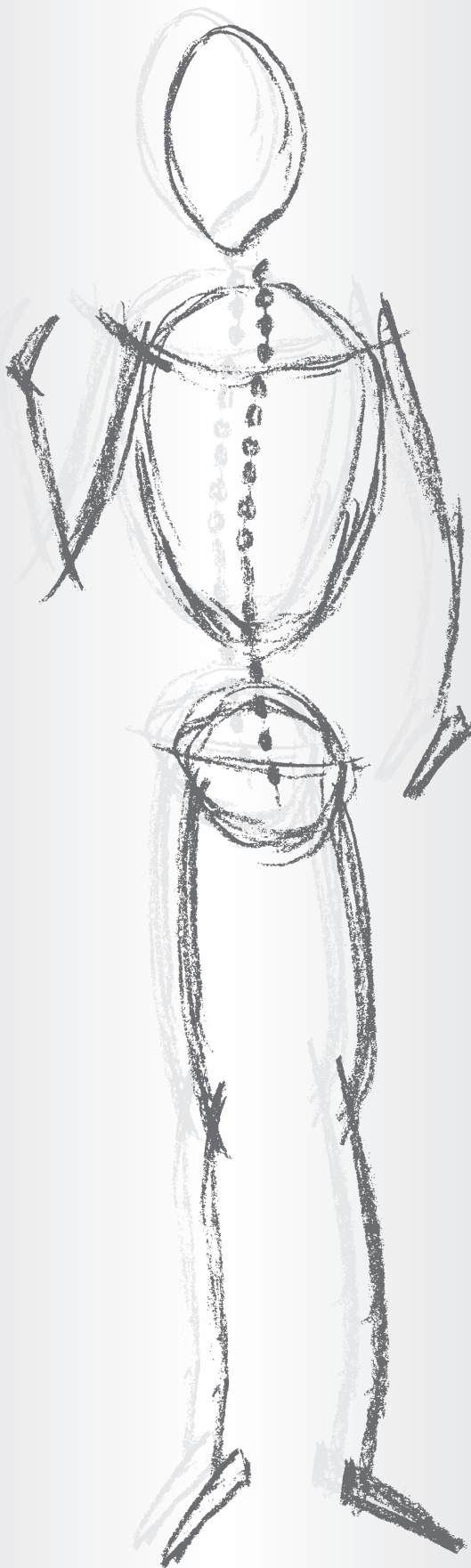

**Reda Instrumente GmbH**  
Gänsäcker 34 - P.O. Box 131  
D-78532 Tuttlingen

**PÄDIATRISCHE UROLOGIE**  
Cystoskopie und Resektoskopie  
9,5 & 11 Char Ø

**PEDIATRIC UROLOGY**  
Cystoscopy and Resectoscopy  
9,5 & 11 Fr. Ø

**UROLOGÍA PEDIÁTRICA**  
Cistoscopia y Resectoscopia  
9,5 & 11 Char Ø

**UROLOGIA PEDIATRICA**  
Cistoscopia e Resettoscopia  
9,5 & 11 Char Ø



[www.Reda-Instrumente.de](http://www.Reda-Instrumente.de)

Optik  
Optic  
Óptica  
Ottica



Blickrichtung  
Angle of view  
Dirección visual  
Angolo di visione

Ø 2,0 mm

0°            **R300-020188-000**

30°           **R300-020188-030**

Cystoskop-Schäfte, Kinder  
 Cystoscopy sheaths, Children  
 Vainas para cistoscopio, pediatricos  
 Camicie per cistoscopio, Pediatrico

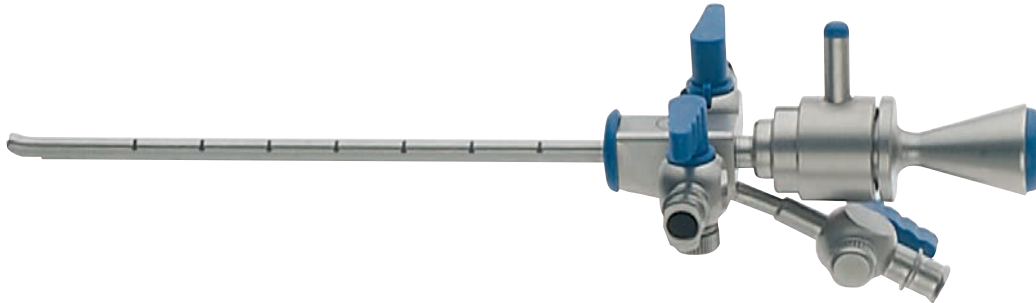

**Ø [Char]**

Cystoskop-Schaft, 2 Hähne fest mit LL-Adapter  
 Cystoscopy sheath, 2 stop cocks fixed with LL-adapters  
 Camisa para cistoscopio, 2 valvulas con adaptador de LL  
 Camicia per cistoscopio, 2 rubinetti fissi con adattatore LL

9,5	Obturator	<b>R310-095000-001</b>
	Sheath	<b>R310-095120-001</b>
	Sheath + Obturator	<b>R311-095120-001</b>

11	Obturator	<b>R310-110000-001</b>
	Sheath	<b>R310-110120-001</b>
	Sheath + Obturator	<b>R311-110120-001</b>

Flexible Instrumente  
Flexible instruments  
Instrumentos flexible  
Instrumenti Flessibili

Imstrumente 30 cm lang  
Instruments 30 cm long  
Instrumentos de 30 cm largo  
Instrumenti lunghezza 30 cm



Biopsiezange  
Biopsy forceps  
Pinza de biopsia  
Pinza per biopsia doppia articolazione

Ø 3 [Char]

**R392-010300-001**



Alligatorfaßzange  
Alligator grasping forceps  
Pinza de agarre  
Pinza da presa tipo alligator doppia articolazione

**R392-010300-011**



Schere  
Scissor  
Tijera  
Forbici mono articolata

**R392-010300-021**



Löffel oval  
Spoon Forceps  
Cuchara oval  
Cucchiaio ovale con  
denti aggressivi

**R392-010300-005**

Resektoskop für Kinder  
 Resectoscope for children  
 Resectoscopio para niños  
 Resettore pediatrico

Arbeitselement  
 Working element  
 Vaina de trabajo  
 Elemento di lavoro

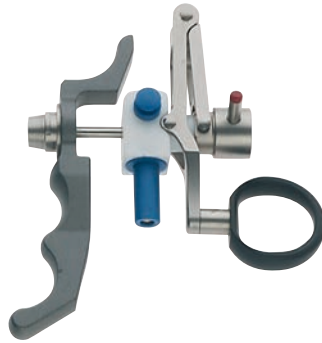

**R320-027110-01**  
 (passiv/passive/pasivo/passivo)



**R320-110110-030**  
 Resektoskop-Schaft Ø 11 Char  
 Resectoscope sheat Ø 11 Char  
 Vaina para resectoscopio de Ø 11 Char  
 Camicia resettore Ø 11 Char

**R320-110000-001**  
 Obturator Ø 11 Char  
 Obturator Ø 11 Char  
 Obturador Ø 11 Char  
 Otturatore Ø 11 Char

Monopolare Elektroden  
 Monopolar electrodes  
 Electrodo monopolar  
 Elettrodo Monopolare

Ø 11 [Char]

**R329-110000-001**



Schlinge retrograde gebogen  
 Loop, retrograde curved  
 Asa, curva retrogradamente  
 Ansa per taglio, angolata

**R329-110000-002**



Schlinge retrograde gebogen #2  
 Loop, retrograde curved #2  
 Asa, curva retrogradamente #2  
 Ansa per taglio, angolata #2

**R329-110040-002**  
 (Ø 2 mm)



Kugel  
 Ball  
 Bola  
 Sferico

**R329-110070-001**



Messer  
 Knife  
 Cuchillo  
 Elettrodo di coagulazione a bisturi

Urethrotomie Kleinkinder  
 Urethrotomy infant  
 Uretrotomia para niños  
 Uretrotomia pediatrico

System für Ø 2,0 mm Optiken  
 System for Ø 2,0 mm telescopes

**R330-110086-01**

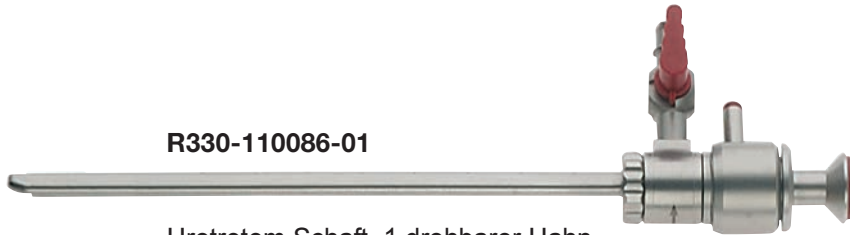

11 Fr.

Urethrotom Schaft, 1 drehbarer Hahn  
 Urethrotome sheath, 1 turnable stopcock  
 Vaina para uretrótomo, 1 llave rotatable  
 Camicia per uretrotomo, 1 rubinetto girevole

**R330-110000-01**

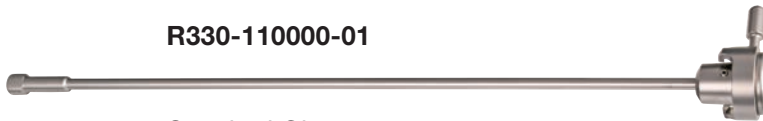

11 Fr.

Standard Obturator  
 Obturator standard  
 Obturador estándar  
 Otturatore standard

**R330-020110-01**

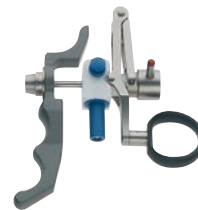

11 Fr.

Arbeitselement, passiv  
 Working element, passive  
 Vaina de trabajo, pasivo  
 Elemento di lavoro, passivo

**R339-110000-01**

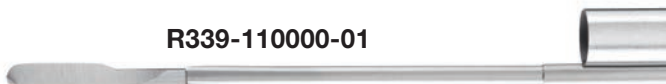

11 Fr.

gerade / straight / recto / retto

**R339-110000-11**

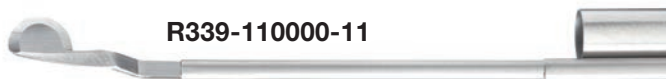

11 Fr.

rund / round shaped / semicircular / semisferico

**R339-110000-41**

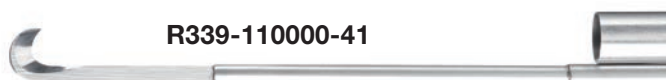

11 Fr.

sichelförmig / sickle shaped / en forma de hoz / ad uncino

**R339-100000-31**

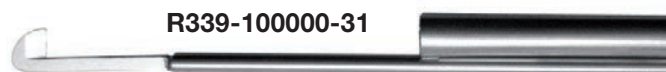

11 Fr.

hakenförmig / hook shaped / en forma de gancho / ad uncino



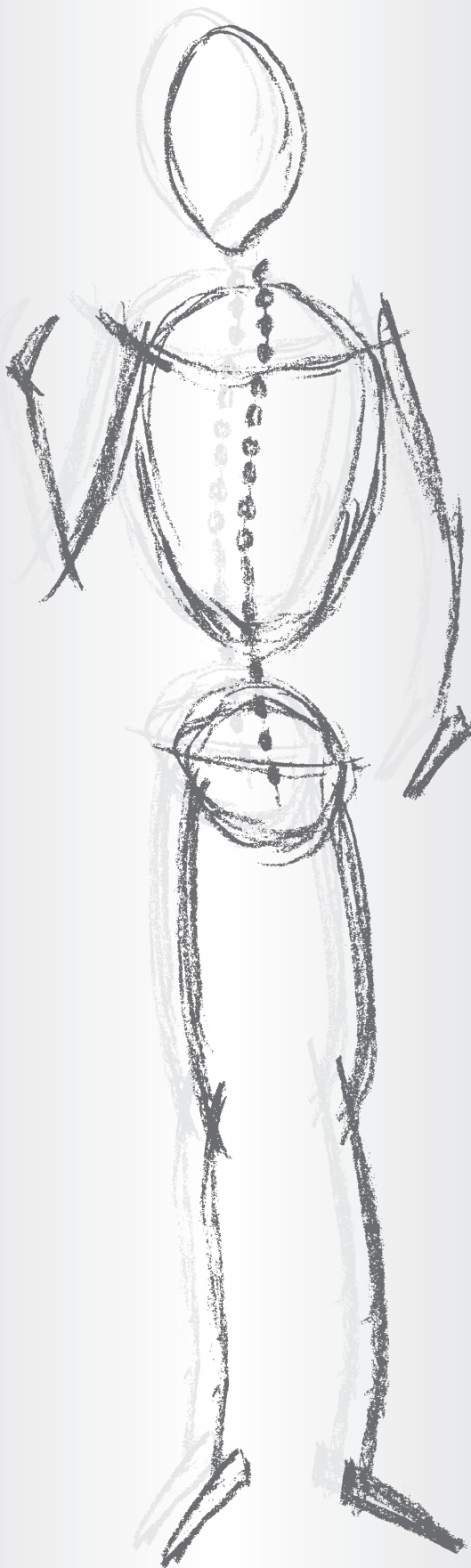

**Reda Instrumente GmbH**  
Gänsäcker 34 - P.O. Box 131  
D-78532 Tuttlingen

**PÄDIATRISCHE UROLOGIE**  
Cystoskopie und Resektoskopie  
13 Char Ø

**PEDIATRIC UROLOGY**  
Cystoscopy and Resectoscopy  
13 Fr. Ø

**UROLOGÍA PEDIÁTRICA**  
Cistoscopia y Resectoscopia  
13 Char Ø

**UROLOGIA PEDIATRICA**  
Cistoscopia e Resettoscopia  
13 Char Ø



[www.Reda-Instrumente.de](http://www.Reda-Instrumente.de)

Optik  
Optic  
Óptica  
Ottica



Blickrichtung  
Angle of view  
Dirección visual  
Angolo di visione

Ø 2,7 mm / length 187 mm

0°	<b>R300-027188-000</b>
30°	<b>R300-027188-030</b>
70°	<b>R300-027188-070</b>

Cystoskop-Schäfte, Kinder  
Cystoscopy sheaths, Children  
Vainas para cistoscopia, pediátricos  
Camicie cistoscopia, Pediatrico



Ø [Char]

Cystoskop-Schaft, 2 Hähne fest mit LL-Adapter  
Cystoscopy sheath, 2 stop cocks fixed with LL-adapters  
Camisa para cistoscopia, 2 valvulas con adaptador de LL  
Camicia per cistoscopia, 2 rubinetti fissi con adattatore LL

13	Obturator	<b>R310-130000-001</b>
	Sheath	<b>R310-130120-001</b>
	Sheath + Obturator	<b>R311-130120-001</b>



Ø [Char]

Albarran Lenkhebel  
Albarran deflector  
Palanca conductor tipo Albarran  
Leva di Albarran

13		<b>R310-027000-011</b>
----	--	------------------------



Ø [Char]

Optikbrücke  
Telescope bridge  
Puente para óptica  
Ponte diagnostico

13		<b>R310-027000-000</b>
----	--	------------------------

Flexible Instrumente  
Flexible instruments  
Instrumentos flexible  
Instrumenti Flessibili

Imstrumente 30 cm lang  
Instruments 30 cm long  
Instrumentos de 30 cm largo  
Instrumenti lunghezza 30 cm



Biopsiezange  
Biopsy forceps  
Pinza de biopsia  
Pinza per biopsia doppia articolazione

Ø 3 [Char]

**R392-010300-001**



Alligatorfaßzange  
Alligator grasping forceps  
Pinza de agarre  
Pinza da presa tipo alligator doppia articolazione

**R392-010300-011**



Schere  
Scissor  
Tijera  
Forbici mono articolata

**R392-010300-021**



Löffel oval  
Spoon Forceps  
Cuchara oval  
Cucchiaio ovale con  
denti aggressivi

**R392-010300-005**

Resektoskop für Kinder  
 Resectoscope for children  
 Resectosopio para niños  
 Resettore pediatrico

Arbeitselement  
 Working element  
 Vaina de trabajo  
 Elemento di lavoro

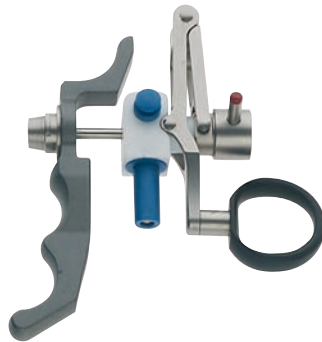

**R320-027110-01**  
 (passiv/passive/pasivo/passivo)



**R320-130110-030**  
 Resektoskop-Schaft Ø 13 Char  
 Resectoscope sheat Ø 13 Char  
 Vaina para resectoscopio de Ø 13 Char  
 Camicia resettore Ø 13 Char

**R320-130000-001**  
 Obturator Ø 13 Char  
 Obturator Ø 13 Char  
 Obturador Ø 13 Char  
 Otturatore Ø 13 Char

Monopolare Elektroden  
 Monopolar electrodes  
 Electrodo Monopolares  
 Monopolar elettrodo



Schlinge retrograde gebogen  
 Loop, retrograde curved  
 Asa, curva retrogradamente  
 Ansa per taglio, angolata

Ø 13 [Char]

**R329-130000-001**



Schlinge retrograde gebogen #2  
 Loop, retrograde curved #2  
 Asa, curva retrogradamente #2  
 Ansa per taglio, angolata #2

**R329-130000-002**



Kugel  
 Ball  
 Bola  
 Sferico

**R329-130040-002**  
 (Ø 2 mm)



Messer  
 Knife  
 Cuchillo  
 Elettrodo di coagulazione a bisturi

**R329-130070-001**

Urethrotomie Kinder  
Urethrotomy children  
Uretrotomia para niños  
Uretrotomia pediatrico

System für Ø 2,7 mm Optiken  
System for Ø 2,7 mm telescopes

**R330-130086-01**

13 Fr.

Urethrotom Schaft, 1 drehbarer Hahn  
Urethrotome sheath, 1 turnable stopcock  
Vaina para uretrótomo, 1 llave rotatable  
Camicia per uretrotomo, 1 rubinetto girevole

**R330-130000-01**

13 Fr.

Standard Obturator  
Obturator standard  
Obturador estándar  
Otturatore standard

**R320-027110-01**

Arbeitselement, passiv  
Working element, passive  
Vaina de trabajo, pasivo  
Elemento di lavoro, passivo

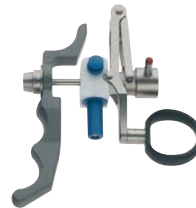

13 Fr.

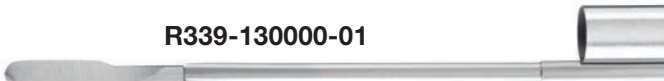
**R339-130000-01**

13 Fr.

gerade / straight / recto / retto

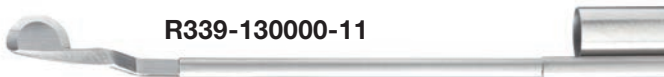
**R339-130000-11**

13 Fr.

rund / round shaped / semicircular / semisferico

**R339-130000-41**

13 Fr.

sichelförmig / sickle shaped / en forma de hoz / ad uncino

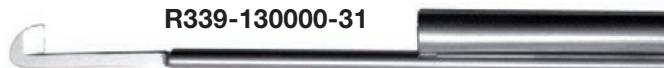
**R339-130000-31**

13 Fr.

hakenförmig / hook shaped / en forma de gancho / ad uncino

**Reda Instrumente GmbH**  
Gänsäcker 34 - P.O. Box 131  
D-78532 Tuttlingen

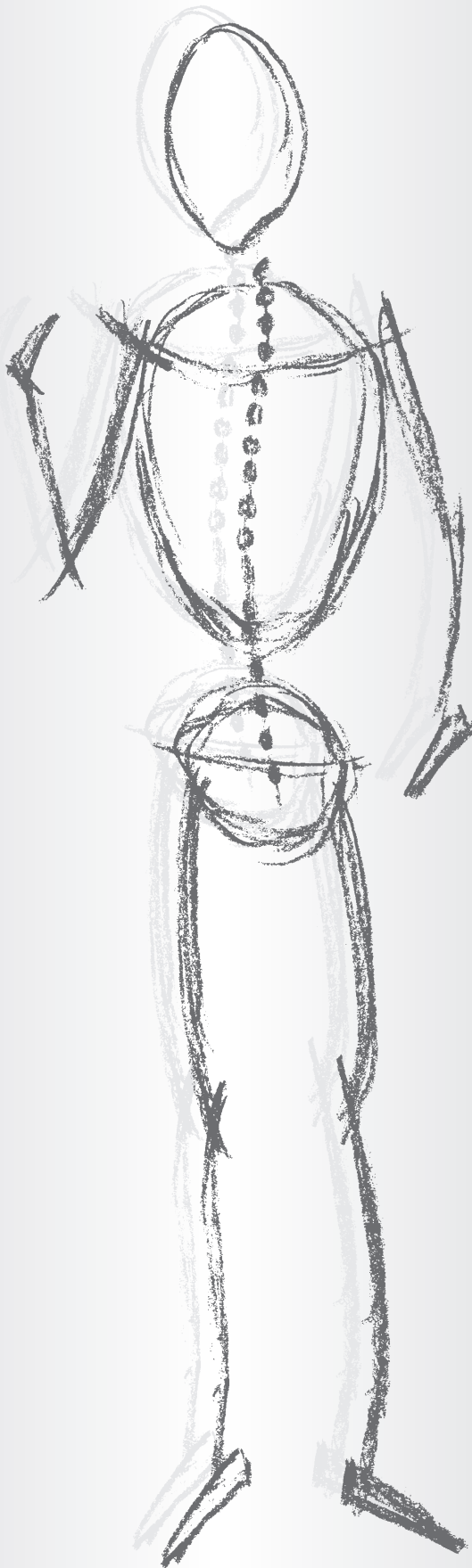

---

**NEPHROSKOPIE**

---

**NEPHROSCOPY**

---

**NEFROSCOPIÁ**

---

**NEFROSCOPIA**



[www.Reda-Instrumente.de](http://www.Reda-Instrumente.de)

Nephroskopie  
Nephroscopy  
Nefroscopía  
Nefroscopia

Nephroskop 7,45 mm Ø, 0° Blickrichtung, autoklavierbar  
Nephroscope 7,45 mm Ø, 0° angle of view, autoclaveable  
Nefroscopio de 7,45 mm Ø, 0° Dirección visual, autoclavable  
Nefroscopio 7,45 mm Ø, 0° Angolo di visione, autoclavabile

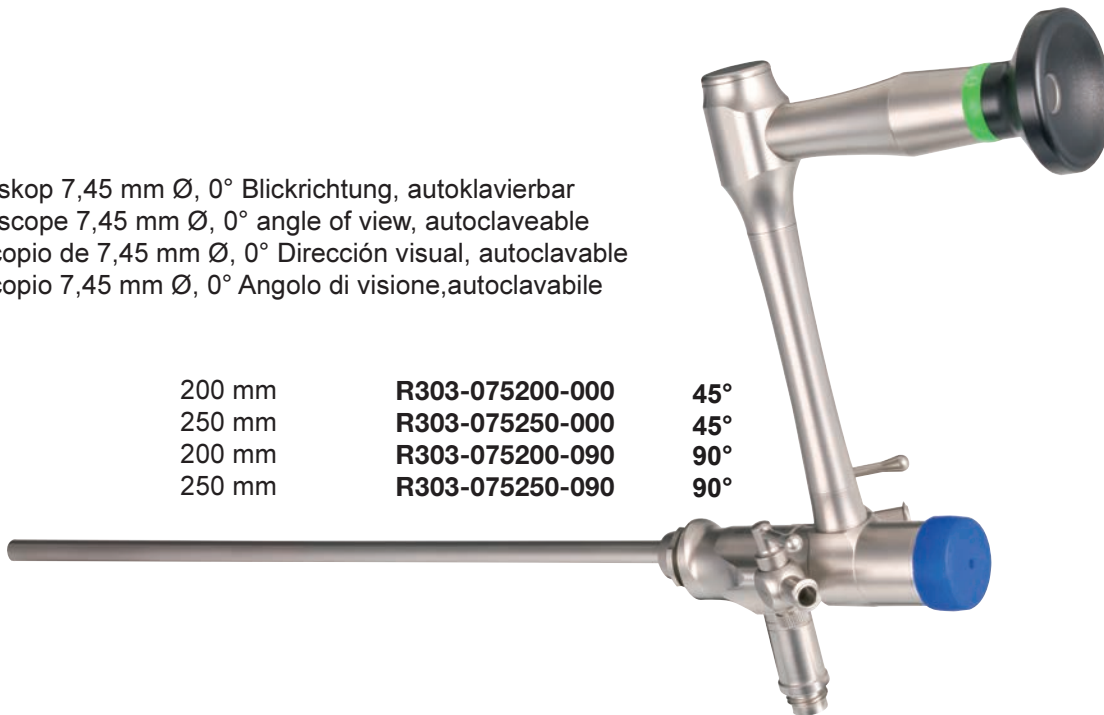

200 mm	<b>R303-075200-000</b>	<b>45°</b>
250 mm	<b>R303-075250-000</b>	<b>45°</b>
200 mm	<b>R303-075200-090</b>	<b>90°</b>
250 mm	<b>R303-075250-090</b>	<b>90°</b>

Nephroscope Operationsschaft, 1 Hahn drehbar  
Nephroscopy operating sheath, 1 stop cock rotatable  
Vaina para nefroscopio, 1 valvula rotable  
Camicia per nefroscopio, 1 rubinetto girevole



20 cm 24 Char	<b>R340-240200-002</b>
25 cm 24 Char	<b>R340-240250-002</b>
20 cm 26 Char	<b>R340-260200-002</b>
25 cm 26 Char	<b>R340-260250-002</b>

Obturator für Nephroskop-Schaft und Fascien Dilatator mit Kanal für Führungsdrähte  
Hollow Obturator and Fascial Dilator for Nephroscop sheath  
Obturator para vaina para nefroscopio y dilatador fascial con canal para guias  
Otturatore per camicia nefroscopio e dilatatore fasciale

20 cm 24 Char	<b>R340-240200-001</b>
25 cm 24 Char	<b>R340-240250-001</b>
20 cm 26 Char	<b>R340-260200-001</b>
25 cm 26 Char	<b>R340-260250-001</b>





**Ø [Char]**

9	<b>R350-090000-001</b>
12	<b>R350-120000-001</b>
15	<b>R350-150000-001</b>
18	<b>R350-180000-001</b>
21	<b>R350-210000-001</b>
24	<b>R350-240000-001</b>
27	<b>R350-270000-001</b>
30	<b>R350-300000-001</b>

**R350-000000-199**

Set für Teleskop Bougies Ø 9 - 24 Char  
Set for telescope bougies Ø 9 - 24 Char  
Set para dilatadores telescopicos Ø 9 - 24 Char  
Set per dilatatori telescopio Ø 9 - 24 Char





**R350-000200-001** (ohne Abb.)

Führungssonde, flexibel  
Guide wire, flexible  
Guia, flexible  
Sonda guida, flessibile

**R350-000100-001** (ohne Abb.)

starr  
rigid  
rigido  
rigido

Instrumente Nephroskopie  
 Instruments nephroscopy  
 Instrumentos para Nefroscopia  
 Instrumenti per Nefroscopia

		30 cm	40 cm
	Biopsiezange Biopsy forceps Pinza de biopsia Pinza per biopsia con doppia articolazione	R396-030300-001	R396-030400-001
	Löffel oval Spoon Forceps Cuchara oval Cucchiaino ovale con denti aggressivi	R396-030300-003	R396-030400-003
	Alligatorfaßzange Alligator grasping forceps Pinza de agarre Pinza da presa tipo alligator con doppia articolazione	R396-030300-011	R396-030400-011
	Schere Scissor Tijera Forbici mono articolata	R396-030300-021	R396-030400-021
	Hakenschere Hook scissor Tijera en forma de gancho Forbici rette uncinatae mono articolate	R396-030300-023	R396-030400-023

**Reda Instrumente GmbH**  
Gänsäcker 34 - P.O. Box 131  
D-78532 Tuttlingen

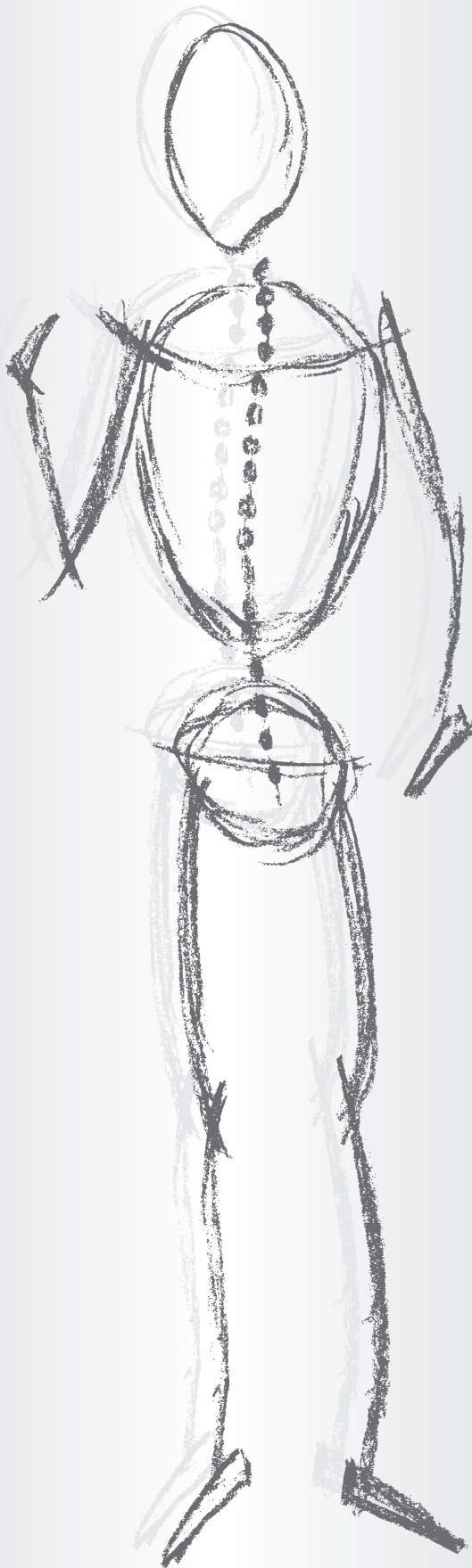

---

**URETERO-RENOSKOPIE**

---

**URETERO-RENSCOPY**

---

**URETERO-RENOSCOPIÁ**

---

**URETERO-RENOSCOPIA**







[www.Reda-Instrumente.de](http://www.Reda-Instrumente.de)

Uretero-Renoskope  
Uretero-Renoscopes  
Uretero-Renoscopio  
Uretero-Renoscopio









<b>Ø [Char]</b>	Ø Arbeitskanal [Char] Ø Working channel [Char] Ø Canal de trabajo [Char] Ø Canale di lavoro [Char]	Nutzlänge Working length Longitud util Lunghezza operativa	Blickrichtung 8° Angle of view 8° Dirección visual 8° Angolo di visione 8°
6 - 9	4	310mm	<b>R302-060310-008</b>
6 - 9	4	425mm	<b>R302-060425-008</b>
7,5 - 10	5	425mm	<b>R302-075425-008</b>



	Ø 3 [Char] Fr.	Ø 3,5 [Char] Fr.	Ø 4 [Char] Fr.	Ø 5 [Char] Fr.
 <p>Biopsiezange Biopsy forceps Pinza para biopsia Pinza per biopsia</p>	R392-010600-001	R392-012600-001	R392-014600-001	R392-017600-001
 <p>Löffelzange gezahnt Spoon forceps serrated Pinza de cuchara dentada Pinza per la rimozione</p>		R392-012600-008	R392-014600-008	R392-017600-008
 <p>Löffelzange lang gezahnt Spoon forceps long serrated Pinza de cuchara, larga dentada Pinza da presa</p>				R392-017600-006
 <p>Löffelzange kurz gezahnt Spoon forceps short serrated Pinza de cuchara, corta dentada Pinza da presa</p>		R392-012600-007		R392-017600-007
 <p>Faßzange gezahnt Grasping forceps serrated Pinza de agarre dentada Pinza da presa</p>		R392-012600-010		

Flexible Instrumente 60 cm  
 Flexible instruments 60 cm  
 Instrumentos flexible 60 cm  
 Instrumenti Flessibili 60 cm

		Ø 3 [Char] Fr.	Ø 3,5 [Char] Fr.	Ø 4 [Char] Fr.	Ø 5 [Char] Fr.
	Alligatorzange Alligator forceps serrated Pinza de agarre Pinza da presa tipo alligator	R392-010600-011	R392-012600-011	R392-014600-011	R392-017600-011
	Steinstrasse lang Grasping forceps Steinstrasse Pinza da calculos larga pinza de presa		R392-012600-013		R392-017600-013
	Fremdkörperzange Stein Foreign Body grasper stone Pinza para cuerpos extraños de calculos Pinza da presa per calculi		R392-012600-014		R392-017600-014
	3-Arm Greifer 3-prong grasper Pinza de agarre de 3 brazos Pinza tripode uncinata	R392-010600-015			R392-017600-015
	Rattenzahnfaßzange Rat tooth grasper Pinza de agarre con diente de raton Pinza da presa	R392-010600-016		R392-014600-016	R392-017600-016
	Fremdkörper Greifzange gefenstert Foreign body grasper fenestrated Pinza de agarre cuerpo extraño Pinza da presa per frammenti		R392-012600-017		R392-017600-017
	Ureter-Schlitzschere Uretero slitting scissors tijera para uréter forbici per incisione dell'uretere		R392-012600-025		R392-017600-025

Dormia Steinfänger  
Dormia stone dislodger  
Malla para rescadar calculus  
Cestello dormia

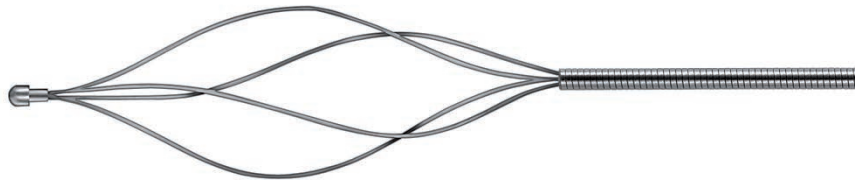

**R394-010600-004**

4 Drähte 3Char/1,0 mm Ø, 600 mm Nutzlänge  
4 wires 3Fr./1,0 mm Ø, 600 mm work.length,  
Malla de 4 alambre de 3 Char/1,0 mm para extraer calculos 600 mm de largo util  
Cestello dormia 4 filamenti, lunghezza 600 mm, Ø1,0 mm

**R394-017600-004**

4 Drähte 5Char/1,7 mm Ø, 600 mm Nutzlänge  
4 wires 5Fr./1,7 mm Ø, 600 mm work.length,  
Malla de 4 alambres de 5 Char/1,7 mm para extraer calculos 600 mm de largo util  
Cestello dormia 4 filamenti, lunghezza 600 mm, Ø1,7 mm

**R394-017600-006**

6 Drähte 5Char/1,7 mm Ø, 600 mm Nutzlänge  
6 wires 5Fr./1,7 mm Ø, 600 mm work.length,  
Malla de 6 alambres de 5 Char/1,7 mm para extraer calculos 600 mm de largo util  
Cestello dormia 6 filamenti, lunghezza 600 mm, Ø1,7 mm



**R394-000000-000**

Griff für Dormia Steinfänger  
handle for Dormia stone dislodger  
mango para Malla para rescadar calculus  
Impugnatura per Cestello dormia



INSTRUMENTE GMBH

---



**Reda Instrumente GmbH**  
Gänsäcker 34 - P.O. Box 131  
D-78532 Tuttlingen

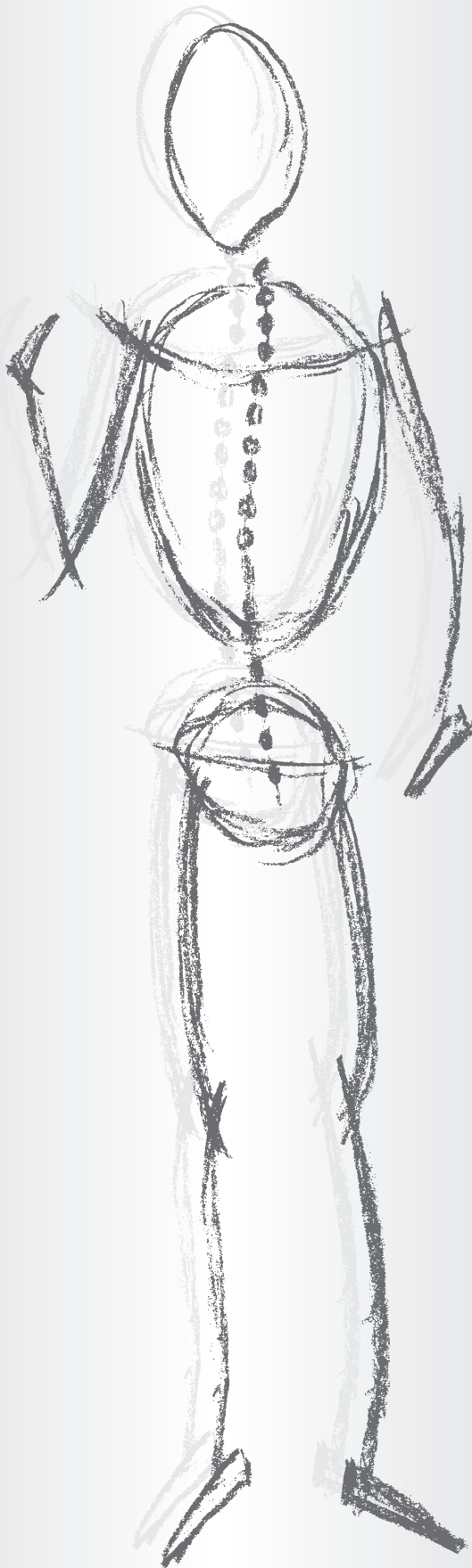

---

**ZUBEHÖR**

---

**ACCESSORIES**

---

**ACCESORIOS**

---

**ACCESSORI**



[www.Reda-Instrumente.de](http://www.Reda-Instrumente.de)

Zubehör Urologie  
Accessories Urology  
Accesorios para urologia  
Accessori Urologia

**67175-08**

STOCKMANN Penisklemme  
STOCKMANN penis seizing fcps.  
STOCKMANN pinza p. el pene  
STOCKMANN pinza serrapene

**67177-11**

STRAUSS Penisklemme  
STRAUSS penis clamp  
STRAUSS pinza p. el pene  
STRAUSS pinza serrapene

Kathetereinführungsinstrumente, Dilatationsbougies  
 Catheter Introducer, Dilating Bougies  
 Introducitor de catéteres, Bujías dilatadoras  
 Mandrini per sonde uretrali, Candelette dilatatrici

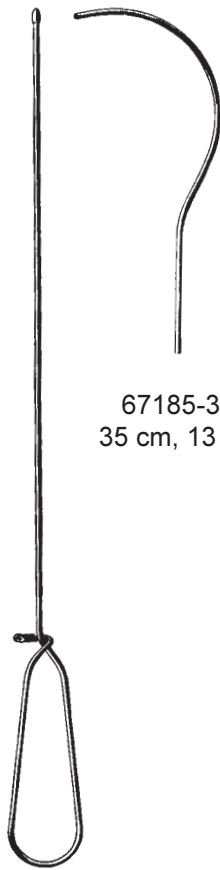

67185-35  
 35 cm, 13 3/4"

GUYON  
 67184-39  
 39 cm, 15 1/2"



Charr. FG	28 cm (11") VAN BUREN	25 cm (10") GUYON	28 cm (11") DITTEL	30 cm (11 3/4") DITTEL
8	67201-08	67205-08	67206-08	67207-08
9			67206-09	67207-09
10	67201-10	67205-10	67206-10	67207-10
11			67206-11	67207-11
12	67201-12	67205-12	67206-12	67207-12
13			67206-13	67207-13
14	67201-14	67205-14	67206-14	67207-14
15			67206-15	67207-15
16	67201-16	67205-16	67206-16	67207-16
17			67206-17	67207-17
18	67201-18	67205-18	67206-18	67207-18
19			67206-19	67207-19
20	67201-20	67205-20	67206-20	67207-20
21			67206-21	67207-21
22	67201-22	67205-22	67206-22	67207-22
23			67206-23	67207-23
24	67201-24	67205-24	67206-24	67207-24
25			67206-25	67207-25
26	67201-26	67205-26	67206-26	67207-26
27			67206-27	67207-27
28	67201-28	67205-28	67206-28	67207-28
29			67206-29	67207-29
30	67201-30	67205-30	67206-30	67207-30
32	67201-32	67205-32		
34	67201-34	67205-34		
36	67201-36	67205-36		
38		67205-38		
40		67205-40		

OTIS Urethrotom für Erwachsene  
OTIS urethrotome for adults  
OTIS uretrótomo para adultos  
OTIS ureterotomo per adulti



Lieferumfang  
extent of delivery

**67169-00**

OTIS Dilatator  
OTIS dilatation  
OTIS instrumento de dilatación  
OTIS dilatatore



3 x Aufsätze (Kugel, Flach, Konisch)  
3 x tips (ball, flat, conical)  
juego de 3 x puntas (bola, plana, cónica)  
set di 3 x punte (a sfera, piatta e conica)

**67169-01**

2 x Messer  
2 x knives  
2 x cuchillos  
2 x bisturi

1 x Box



Blasenspritzen  
Bladder springs  
Jeringa para vejiga  
Siringa vescicale



Blasenspritze  
Bladder spring  
Jeringa para vejiga  
Siringa vescicale

Ersatzzylinder  
Spare barrels  
Cilindros de repuesto  
Cilindri di ricambio

50ml	<b>R390-000050-001</b>
75ml	<b>R390-000075-001</b>
100ml	<b>R390-000100-001</b>
150ml	<b>R390-000150-001</b>

<b>R390-000050-999</b>
<b>R390-000075-999</b>
<b>R390-000100-999</b>
<b>R390-000150-999</b>

Evakuator nach ELLIK  
Evacuator acc to ELLIK  
Evacuador segun ELLIK  
Evacuatore sec. ELLIK



**R390-100000-000**  
Komplett  
complete  
completo  
completo

**R390-100000-100**  
Gummiball  
Rubber ball  
Pera de goma  
Pompetta in gomma

**R390-100000-300**  
Schlauch mit Verriegelungs-Adapter  
Tube with locking device  
Tubo con adattador  
Tubo con adattatore

**R390-100000-200**  
Glasbehälter  
Glass recipient  
Recipiente de vidrio  
Recipiente in vetro

**R390-100000-400**  
Konus mit Schlauchteil  
Cone adapter with tube  
Cono con tubo  
Cono con segmento di Tubo

Zubehör Urologie  
Accesories Urology  
Accesorios para urologia  
Accessori Urologia

Luerlock-Schlauchverbinder  
luer-lock tubing connector  
luer-luck conector para el tubo  
luer-lock connettore per tubi



**R070-000060-101**  
männlich  
male  
macho  
maschio



**R070-000060-201**  
weiblich  
female  
femenino  
femminile

Luerlock-Schlauchverbinder mit Hahn  
luer-lock tubing connector with stopcock  
luer-lock conector para el tubo con llave  
luer-lock connettore per tubi; con rubinetto

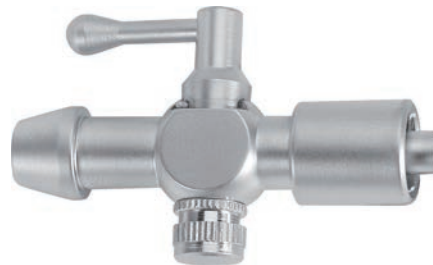

**R070-000060-001**  
männlich  
male  
macho  
maschio

**R070-000060-301**  
weiblich  
female  
femenino  
femminile

Adapter für Blasenkatheter  
Adapter for bladder catheter  
Adaptador para Catéter  
Adattore per Catetero



**R390-9001**

Dichtkappe für Instrumentenkanal  
sealing cap for instrument channel  
capuchon de cierre para canal de instrumentos  
tappino in gomma; per canale strumenti



**R210-000010-011**  
1 mm

**R210-000020-011**  
2 mm

67169-00	UR76	67206-21	UR75	R300-040302-070	UR 8
67169-01	UR76	67206-22	UR75	R302-060310-008	UR68
67175-08	UR74	67206-23	UR75	R302-060425-008	UR68
67177-11	UR74	67206-24	UR75	R302-075310-008	UR68
67184-39	UR75	67206-25	UR75	R302-075425-008	UR68
67185-35	UR75	67206-26	UR75	R303-075200-000	UR64
67201-08	UR75	67206-27	UR75	R303-075200-090	UR64
67201-10	UR75	67206-28	UR75	R303-075250-000	UR64
67201-12	UR75	67206-29	UR75	R303-075250-090	UR64
67201-14	UR75	67206-30	UR75	R310-027000-000	UR59
67201-16	UR75	67207-08	UR75	R310-027000-011	UR59
67201-18	UR75	67207-09	UR75	R310-029000-000	UR36
67201-20	UR75	67207-10	UR75	R310-029000-001	UR36
67201-22	UR75	67207-11	UR75	R310-029000-002	UR36
67201-24	UR75	67207-12	UR75	R310-029000-011	UR37
67201-26	UR75	67207-13	UR75	R310-029000-012	UR37
67201-28	UR75	67207-14	UR75	R310-040000-000	UR12
67201-30	UR75	67207-15	UR75	R310-040000-001	UR12
67201-32	UR75	67207-16	UR75	R310-040000-002	UR12
67201-34	UR75	67207-17	UR75	R310-040000-011	UR13
67201-36	UR75	67207-18	UR75	R310-040000-012	UR13
67205-08	UR75	67207-19	UR75	R310-040000-021	UR13
67205-10	UR75	67207-20	UR75	R310-040000-022	UR13
67205-12	UR75	67207-21	UR75	R310-095000-001	UR53
67205-14	UR75	67207-22	UR75	R310-095120-001	UR53
67205-16	UR75	67207-23	UR75	R310-110000-001	UR53
67205-18	UR75	67207-24	UR75	R310-110120-001	UR53
67205-20	UR75	67207-25	UR75	R310-130000-001	UR59
67205-22	UR75	67207-26	UR75	R310-130120-001	UR59
67205-24	UR75	67207-27	UR75	R310-150000-001	UR35
67205-26	UR75	67207-28	UR75	R310-150235-001	UR35
67205-28	UR75	67207-29	UR75	R310-170000-001	UR10
67205-30	UR75	67207-30	UR75	R310-170000-003	UR10
67205-32	UR75	R070-000060-001	UR78	R310-170235-001	UR10
67205-34	UR75	R070-000060-101	UR78	R310-190000-001	UR10
67205-36	UR75	R070-000060-201	UR78	R310-190000-003	UR10
67205-38	UR75	R070-000060-301	UR78	R310-190235-001	UR10
67205-40	UR75	R210-000010-011	UR78	R310-210000-001	UR10
67206-08	UR75	R210-000020-011	UR78	R310-210000-003	UR10
67206-09	UR75	R300-020188-000	UR52	R310-210235-001	UR10
67206-10	UR75	R300-020188-030	UR52	R310-230000-001	UR10
67206-11	UR75	R300-027188-000	UR58	R310-230000-003	UR10
67206-12	UR75	R300-027188-030	UR58	R310-230235-001	UR10
67206-13	UR75	R300-027188-070	UR58	R310-240000-001	UR20
67206-14	UR75	R300-029302-000	UR34	R310-250000-001	UR10
67206-15	UR75	R300-029302-015	UR34	R310-250000-003	UR10
67206-16	UR75	R300-029302-030	UR34	R310-250235-001	UR10
67206-17	UR75	R300-029302-070	UR34	R311-095120-001	UR53
67206-18	UR75	R300-040302-000	UR 8	R311-110120-001	UR53
67206-19	UR75	R300-040302-015	UR 8	R311-130120-001	UR59
67206-20	UR75	R300-040302-030	UR 8	R311-150235-001	UR35

R311-170235-001	UR10	R320-220190-130	UR43	R329-240054-003	UR28
R311-190235-001	UR10	R320-240000-001	UR26	R329-240054-005	UR28
R311-210235-001	UR10	R320-240000-002	UR26	R329-240055-001	UR27
R311-230235-001	UR10	R320-240000-003	UR26	R329-240056-001	UR27
R311-250235-001	UR10	R320-240000-005	UR26	R329-240070-001	UR28
R312-040000-01	UR20	R320-240000-030	UR24	R329-240090-003	UR28
R312-150000-001	UR11	R320-240000-130	UR24	R329-270000-001	UR27
R312-150235-001	UR11	R320-260000-030	UR24	R329-270010-001	UR27
R312-170235-001	UR11	R320-260000-130	UR24	R329-270030-001	UR27
R312-190235-001	UR11	R320-260240-030	UR25	R329-270040-003	UR27
R312-210235-001	UR11	R320-260240-130	UR25	R329-270040-005	UR27
R312-230235-001	UR11	R320-270000-001	UR26	R329-270050-003	UR27
R312-250235-001	UR11	R320-270000-002	UR26	R329-270050-005	UR27
R313-150235-001	UR11	R320-270000-003	UR26	R329-270055-001	UR27
R313-170235-001	UR11	R320-270000-005	UR26	R329-990	UR28
R313-190235-001	UR11	R320-270000-030	UR24	R330-110000-01	UR56
R313-210235-001	UR11	R320-270000-130	UR24	R330-110086-01	UR56
R313-230235-001	UR11	R320-285000-030	UR24	R330-130000-01	UR62
R313-240235-001	UR20	R320-285000-130	UR24	R330-130086-01	UR62
R313-250235-001	UR11	R320-285270-030	UR25	R330-155000-11	UR49
R315-021000-01	UR14	R320-285270-130	UR25	R330-155201-01	UR48
R315-021000-011	UR14	R329-040000-003	UR23	R330-155201-102	UR48
R315-021000-021	UR14	R329-040000-005	UR23	R330-210000-01	UR31
R315-021000-06	UR14	R329-040000-203	UR23	R330-210000-11	UR31
R315-021000-30	UR15	R329-040000-205	UR23	R330-210201-01	UR30
R315-021000-70	UR15	R329-050000-003	UR23	R330-230201-001	UR30
R315-240000-59	UR20	R329-050000-005	UR23	R330-230201-102	UR30
R315-250000-39	UR20	R329-080000-003	UR23	R339-029000-001	UR49
R315-901	UR15	R329-080000-005	UR23	R339-040000-001	UR31
R315-902	UR15	R329-110000-001	UR55	R339-110000-001	UR56
R319-900-01	UR13	R329-110000-002	UR55	R339-110000-011	UR56
R320-027110-01	UR55	R329-110040-002	UR55	R339-110000-031	UR56
R320-027225-01	UR40	R329-110070-001	UR55	R339-110000-041	UR56
R320-027225-02	UR40	R329-130000-001	UR61	R339-130000-001	UR62
R320-027225-11	UR40	R329-130000-002	UR61	R339-130000-011	UR62
R320-027225-12	UR40	R329-130040-002	UR61	R339-130000-031	UR62
R320-040225-01	UR22	R329-130070-001	UR61	R339-130000-041	UR62
R320-040225-02	UR22	R329-190000-001	UR45	R339-155000-001	UR50
R320-040225-11	UR22	R329-190030-001	UR45	R339-155000-002	UR50
R320-040225-12	UR22	R329-190040-002	UR45	R339-155000-011	UR50
R320-110000-001	UR55	R329-190050-003	UR45	R339-155000-031	UR50
R320-110110-030	UR55	R329-190070-001	UR45	R339-210000-001	UR32
R320-130000-001	UR61	R329-240000-001	UR27	R339-210000-002	UR32
R320-130110-030	UR61	R329-240010-001	UR27	R339-210000-011	UR32
R320-190000-001	UR44	R329-240030-001	UR27	R339-210000-021	UR32
R320-190000-003	UR44	R329-240040-003	UR27	R339-210000-031	UR32
R320-190000-030	UR42	R329-240040-005	UR27	R340-240200-001	UR64
R320-190000-130	UR42	R329-240050-003	UR27	R340-240200-002	UR64
R320-220000-030	UR42	R329-240050-005	UR27	R340-240250-001	UR64
R320-220000-130	UR42	R329-240052-003	UR28	R340-240250-002	UR64
R320-220190-030	UR43	R329-240052-005	UR28	R340-260200-001	UR64



R340-260200-002	UR64	R392-012600-013	UR70	R394-017600-004	UR18
R340-260250-001	UR64	R392-012600-014	UR70	R394-017600-006	UR18
R340-260250-002	UR64	R392-012600-017	UR70	R395-000000-000	UR19
R350-000000-199	UR65	R392-012600-025	UR70	R395-010450-001	UR19
R350-000100-001	UR65	R392-012800-025	UR70	R395-010450-021	UR19
R350-000200-001	UR65	R392-014400-001	UR38	R395-017400-125	UR19
R350-090000-001	UR65	R392-014400-011	UR38	R395-017450-001	UR19
R350-120000-001	UR65	R392-014400-021	UR38	R395-017450-011	UR19
R350-150000-001	UR65	R392-014600-001	UR69	R395-017450-021	UR19
R350-180000-001	UR65	R392-014600-008	UR69	R395-023400-125	UR19
R350-210000-001	UR65	R392-014600-011	UR70	R395-023450-001	UR19
R350-240000-001	UR65	R392-014600-016	UR70	R395-023450-011	UR19
R350-270000-001	UR65	R392-017400-001	UR16	R395-023450-021	UR19
R350-300000-001	UR65	R392-017400-003	UR16	R395-030450-001	UR19
R390-000050-001	UR77	R392-017400-005	UR16	R395-030450-011	UR19
R390-000050-999	UR77	R392-017400-011	UR17	R396-030300-001	UR66
R390-000075-001	UR77	R392-017400-021	UR17	R396-030300-003	UR66
R390-000075-999	UR77	R392-017600-001	UR69	R396-030300-011	UR66
R390-000100-001	UR77	R392-017600-006	UR69	R396-030300-021	UR66
R390-000100-999	UR77	R392-017600-007	UR69	R396-030300-023	UR66
R390-000150-001	UR77	R392-017600-008	UR69	R396-030400-001	UR66
R390-000150-999	UR77	R392-017600-011	UR70	R396-030400-003	UR66
R390-000200-001	UR77	R392-017600-013	UR70	R396-030400-011	UR66
R390-000200-999	UR77	R392-017600-014	UR70	R396-030400-021	UR66
R390-100000-000	UR77	R392-017600-015	UR70	R396-030400-023	UR66
R390-100000-001	UR77	R392-017600-016	UR70		
R390-100000-100	UR77	R392-017600-017	UR70		
R390-100000-200	UR77	R392-017600-025	UR70		
R390-100000-300	UR77	R392-021400-001	UR16		
R390-100000-400	UR77	R392-021400-003	UR16		
R390-9001	UR78	R392-021400-005	UR16		
R392-010300-001	UR54	R392-021400-006	UR16		
R392-010300-005	UR54	R392-021400-011	UR17		
R392-010300-011	UR54	R392-021400-021	UR17		
R392-010300-021	UR54	R392-023400-001	UR16		
R392-010400-001	UR38	R392-023400-003	UR16		
R392-010400-005	UR38	R392-023400-004	UR16		
R392-010400-011	UR38	R392-023400-005	UR16		
R392-010400-021	UR38	R392-023400-009	UR16		
R392-010600-001	UR69	R392-023400-011	UR17		
R392-010600-011	UR70	R392-023400-014	UR17		
R392-010600-015	UR70	R392-023400-021	UR17		
R392-010600-016	UR70	R392-023400-022	UR17		
R392-012400-001	UR38	R392-023400-023	UR17		
R392-012400-011	UR38	R392-030400-001	UR16		
R392-012400-021	UR38	R392-030400-003	UR16		
R392-012600-001	UR69	R392-030400-011	UR17		
R392-012600-007	UR69	R392-030400-021	UR17		
R392-012600-008	UR69	R392-030400-023	UR17		
R392-012600-010	UR69	R394-000000-000	UR18		
R392-012600-011	UR70	R394-010600-004	UR71		

Weitere Kataloge und Prospekte  
Other catalogues and prospects

Hauptkatalog Chirurgische Instrumente  
General catalog surgical instruments

Endoskopie  
Endoscopy

Titan Instrumente  
Titanium Instruments

Container Steriltechnik  
Container Sterilization Technique

HERCULES® Drahtkneifzange  
HERCULES® Wire Cutters

Neurochirurgie  
Neuro surgery

Plastische Chirurgie  
Plastic surgery

Orthopädie  
Orthopedic

Arthroskopie  
Arthroscopy



Gänsäcker 34  
P.O. Box 131  
D-78532 Tuttlingen  
Germany



Fon +49 74 62.94 45-0  
Fax +49 74 62.94 45-20  
[info@Reda-Instrumente.de](mailto:info@Reda-Instrumente.de)  
[www.Reda-Instrumente.de](http://www.Reda-Instrumente.de)