



ARTHROSCOPY

REDA

INSTRUMENTE GMBH

Reda Instrumente GmbH
Gänsäcker 34 - P.O. Box 131
D-78532 Tuttlingen

Telefon +49/7462/9445-0
Telefax +49/7462/9445-20
e-mail: info@Reda-Instrumente.de
<http://www.Reda-Instrumente.de>

Ausgabe Nr. 4
Datum: 2019

Endoskope für Arthroskopie
Endoscopes for Arthroscopy
Endoscopios para artroscopía

Ø 4 mm

Arthroskop, autoklavierbar mit integrierter Faser zur Beleuchtung für diagnostische und operative Eingriffe, Ø 4 mm, Arbeitslänge 175 mm:
Knie, Perkutane Nukleotomie, lumbaler Bandscheibenvorfall, für Schulter-Arthroskopie.

Arthroscope, autoclavable, with integrated fiber optic for illumination, for diagnostic and operation, Ø 4 mm, working length 175 mm:
Knee, percutaneous nucleotomy, shoulder arthroscopy.

Artroscopios (ópticas) autoclavables con fibraoptica incorporado para intervenciones diagnósticas y operativas, diámetro de 4 mm, largo útil 175 mm:
rodilla, nucleotomía percutanea, hernias lumbales y artroscopía de la espalda y hombro.

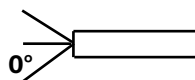
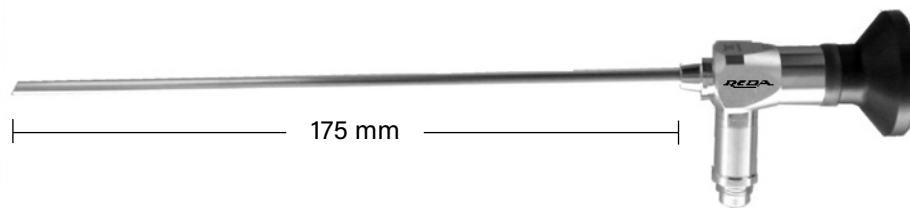

0°

Geradeausblick
Direct vision
Vision directa

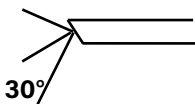
R400-040175-000

30°

Vorausblick
Foroblique vision
ángulo de

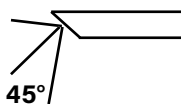
R400-040175-030

45°

Vorausblick
Foroblique vision
ángulo de

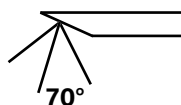
R400-040175-045

70°

Seitblick
Lateral vision
ángulo de

R400-040175-070

Arthroskopieschäfte für Endoskope mit Ø 4 mm
 Arthroscopy Sheath for endoscopes with Ø 4 mm
 Vainas para artroscopia para endoscopios de Ø 4 mm

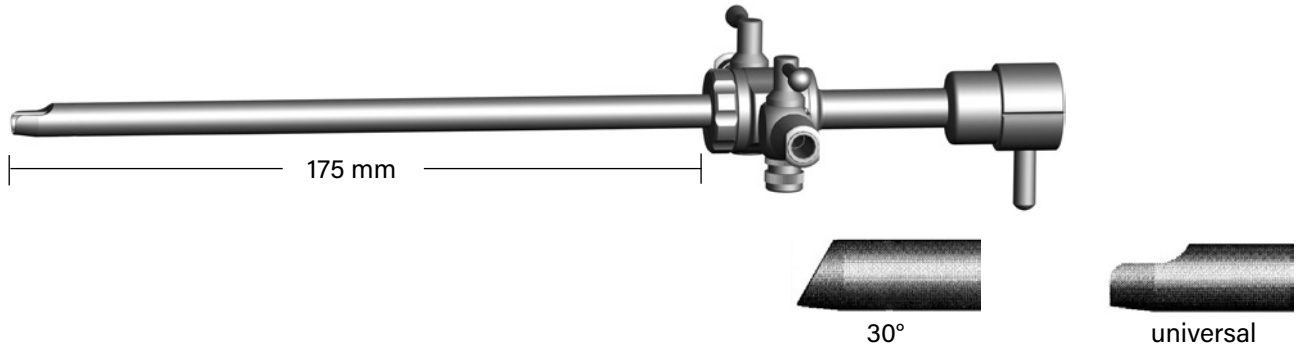

Trokar-Hülse mit zwei Spülhähnen, drehbar, 4 mm Ø
 Trocar sleeve, with two stop cocks rotating, 4 mm Ø
 Tubo con dos llaves giratorias, de 4 mm Ø

R414-040175-030

R414-040175-070

mit einem Spülhahn drehbar
 with one stop cock rotating
 con una llave giratoria

R413-040175-030

R413-040175-070

Obturator 4 mm Ø
Obturator 4 mm Ø
Obturador de 4 mm Ø



scharf / sharp / agudo

R410-040175-001



konisch stumpf / conical blunt / cónico romo

R410-040175-002



stumpf / blunt / romo

R410-040175-003

Endoskope für Arthroskopie
Endoscopes for Arthroscopy
Endoscopios para artroscopía

Ø 2,7 mm

Arthroskop, autoklavierbar mit integrierter Faser zur Beleuchtung für diagnostische und operative Eingriffe,
Ø 2,7 mm, Arbeitslänge 110 mm:
Kleine Gelenke und Karpaltunnel

Arthroscope, autoclavable, with integrated fiber optic for illumination, for diagnostic and operation,
Ø 2.7 mm, working length 110 mm:
small joints and carpal tunnel

Artroscopios (ópticas) autoclavables con fibraoptica incorporado para intervenciones diagnósticas y operativas,
diámetro de 2,7 mm, largo útil 110 mm:
articulaciones pequeñas

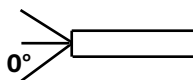
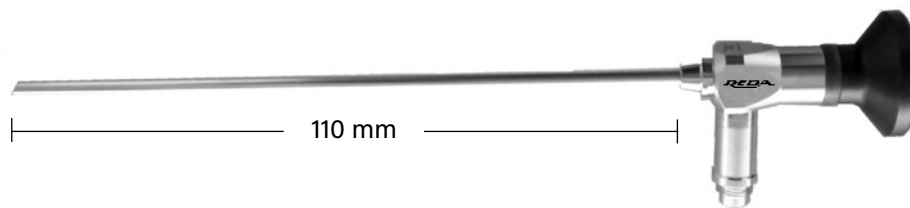

Geradeausblick
Direct vision
Vision directa

R400-027110-000

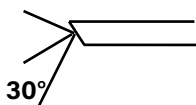

Vorausblick
Foroblique vision
ángulo de

R400-027110-030

Arthroskopieschäfte für Endoskope mit Ø 2,7 mm
Arthroscopy Sheath for endoscopes with Ø 2,7 mm
Vainas para artroscopia para endoscopios de Ø 2,7 mm

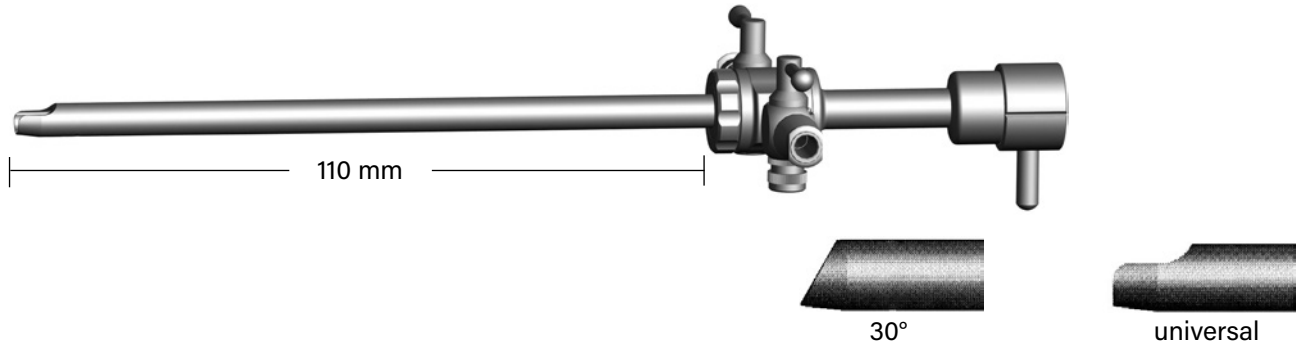

Trokar-Hülse mit zwei Spülhähnen, drehbar, 2,7 mm Ø
Trocar sleeve, with two stop cocks rotating, 2.7 mm Ø
Tubo con dos llaves giratorias, de 2,7 mm Ø

R414-027110-030

R414-027110-070

mit einem Spülhahn drehbar
with one stop cock rotating
con una llave giratoria

R413-027110-030

R413-027110-070

Obturator 2,7 mm Ø
Obturator 2.7 mm Ø
Obturador de 2,7 mm Ø



scharf / sharp / agudo

R410-027110-001



konisch stumpf / conical blunt / cónico romo

R410-027110-002



stumpf / blunt / romo

R410-027110-003

Endoskope für Arthroskopie
Endoscopes for Arthroscopy
Endoscopios para artroscopía

Ø 2,7 mm

Arthroskop, autoklavierbar mit integrierter Faser zur Beleuchtung für diagnostische und operative Eingriffe,
Ø 2,7 mm, Arbeitslänge 175 mm:
Kleine Gelenke

Arthroscope, autoclavable, with integrated fiber optic for illumination, for diagnostic and operation,
Ø 2.7 mm, working length 175 mm:
small joint

Artroscopios (ópticas) autoclavables con fibroptica incorporado para intervenciones diagnósticas y operativas,
diámetro de 2,7 mm, largo útil 175 mm:
articulaciones pequeñas

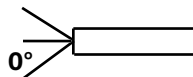
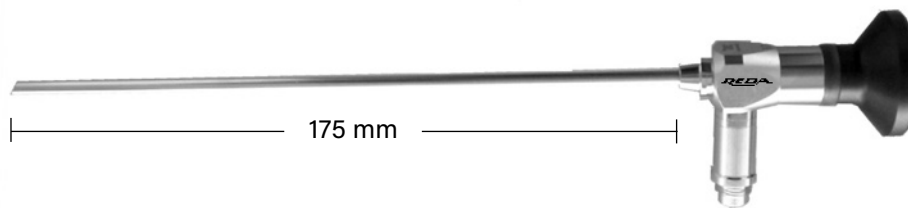

Geradeausblick
Direct vision
Vision directa

R400-027175-000

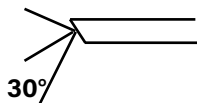

Vorausblick
Foroblique vision
ángulo de

R400-027175-030

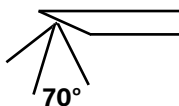

Seitblick
Lateral vision
ángulo de

R400-027175-070

Arthroskopieschäfte für Endoskope mit Ø 2,7 mm
 Arthroscopy Sheath for endoscopes with Ø 2,7 mm
 Vainas para artroscopia para endoscopios de Ø 2,7 mm

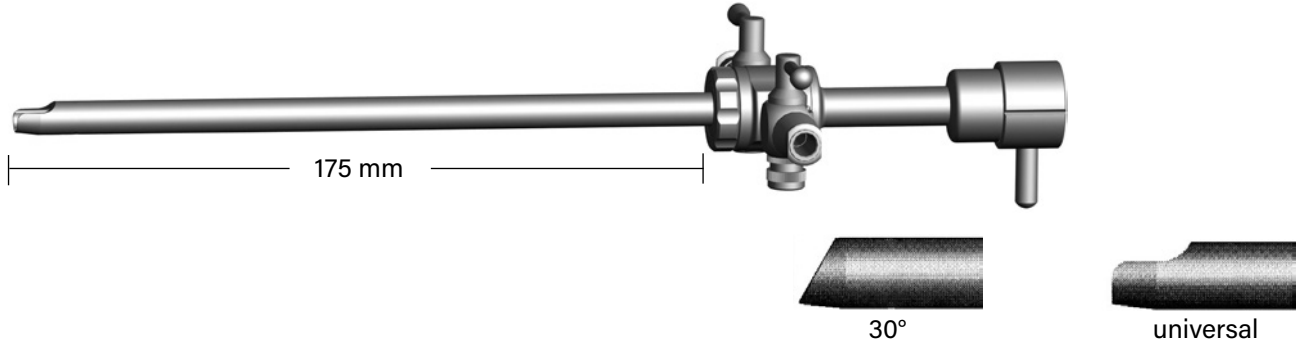

Trokar-Hülse mit zwei Spülhähnen, drehbar, 2,7 mm Ø
 Trocar sleeve, with two stop cocks rotating, 2.7mm Ø
 Tubo con dos llaves giratorias, de 2,7 mm Ø

R414-027175-030

R414-027175-070

mit einem Spülhahn drehbar
 with one stop cock rotating
 con una llave giratoria

R413-027175-030

R413-027175-070

Obturator 2,7 mm Ø
Obturator 2.7 mm Ø
Obturador de 2,7 mm Ø



scharf / sharp / agudo

R410-027175-001



konisch stumpf / conical blunt / cónico romo

R410-027175-002



stumpf / blunt / romo

R410-027175-003

Endoskope für Arthroskopie
Endoscopes for Arthroscopy
Endoscopios para artroscopía

Ø 2,7 mm

Arthroskop, autoklavierbar mit integrierter Faser zur Beleuchtung für diagnostische und operative Eingriffe,
Ø 2,7 mm, Arbeitslänge 188 mm:
Schulter

Arthroscope, autoclavable, with integrated fiber optic for illumination, for diagnostic and operation,
Ø 2.7 mm, working length 188 mm:
shoulder

Artroscopios (ópticas) autoclavables con fibraoptica incorporado para intervenciones diagnósticas y operativas,
diámetro de 2,7 mm, largo útil 188 mm:
hombro

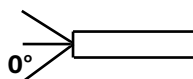
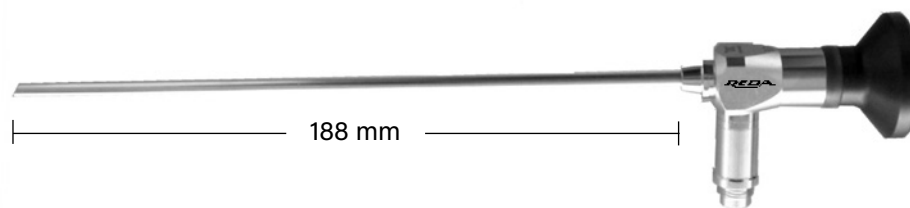

Geradeausblick
Direct vision
Vision directa

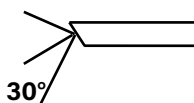
R400-027188-000

Vorausblick
Foroblique vision
ángulo de

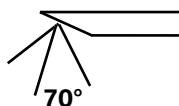
R400-027188-030

Seitblick
Lateral vision
ángulo de

R400-027188-070

Arthroskopieschäfte für Endoskope mit Ø 2,7 mm
 Arthroscopy Sheath for endoscopes with Ø 2,7 mm
 Vainas para artroscopia para endoscopios de Ø 2,7 mm

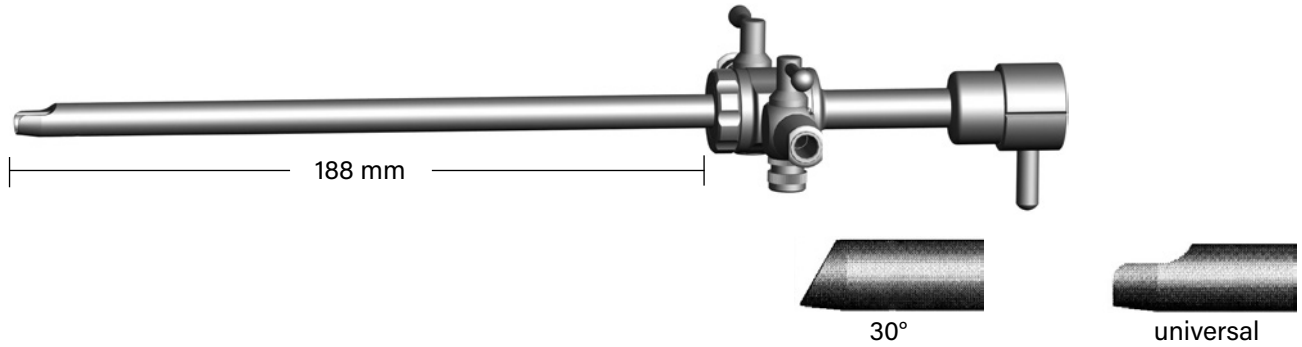

Trokar-Hülse mit zwei Spülhähnen, drehbar, 2,7 mm Ø
 Trocar sleeve, with two stop cocks rotating, 2.7mm Ø
 Tubo con dos llaves giratorias, de 2,7 mm Ø

R414-027188-030

R414-027188-070

mit einem Spülhahn drehbar
 with one stop cock rotating
 con una llave giratoria

R413-027188-030

R413-027188-070

Obturator 2,7 mm Ø
Obturator 2.7 mm Ø
Obturador de 2,7 mm Ø



scharf / sharp / agudo

R410-027188-001



konisch stumpf / conical blunt / cónico romo

R410-027188-002



stumpf / blunt / romo

R410-027188-003

Hakenstanze, mit Schippe
 Hook punch, scoope nose
 Pinza cortante, de nariz aguda

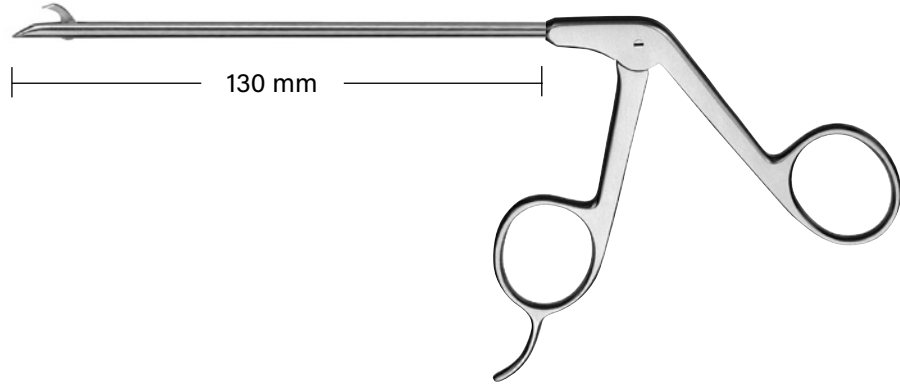

3,4 mm Ø
 cutting size 5 x 1,6

2,8 mm Ø
 cutting size 4 x 1,2

Hakenstanze mit Schippe
 Hook punch, scoope nose
 Pinza cortante, de nariz aguda



gerade / straight / recta

R440-034130-000

R440-028130-000

Schaft gebogen / shaft curved
 vaina curva:



30°

rechts / right / derecha

R440-034130-030

R440-028130-030

links / left / izquierda

R440-034130-130

R440-028130-130



45°

rechts / right / derecha

R440-034130-045

R440-028130-045

links / left / izquierda

R440-034130-145

R440-028130-145



7°

aufwärts / upwards
 hacia arriba

R440-034130-007

R440-028130-007

abwärts / downwards
 hacia abajo

R440-034130-107

R440-028130-107



15°

aufwärts / upwards
 hacia arriba

R440-034130-015

R440-028130-015

abwärts / downwards
 hacia abajo

R440-034130-115

R440-028130-115

Hakenstanze, mit Schippe 15°
 Hook punch, scoope nose 15°
 Pinza cortante, de nariz aguda 15°

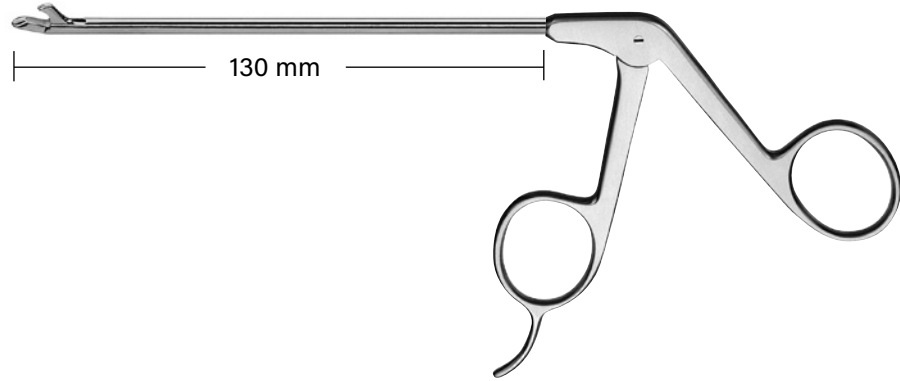

3,4 mm Ø
 cutting size 5 x 1,6

2,8 mm Ø
 cutting size 4 x 1,2

Hakenstanze mit Schippe
 Hook punch, scoope nose
 Pinza cortante, de nariz aguda



gerade / straight / recta

R440-034130-200

R440-028130-200



30°

Schaft gebogen / shaft curved
 vaina curva:

rechts / right / derecha

R440-034130-230

R440-028130-230

links / left / izquierda

R440-034130-330

R440-028130-330



45°

rechts / right / derecha

R440-034130-245

R440-028130-245

links / left / izquierda

R440-034130-345

R440-028130-345



7°

aufwärts / upwards
 hacia arriba

R440-034130-207

R440-028130-207



abwärts / downwards
 hacia abajo

R440-034130-307

R440-028130-307



15°

aufwärts / upwards
 hacia arriba

R440-034130-215

R440-028130-215



abwärts / downwards
 hacia abajo

R440-034130-315

R440-028130-315

Hakenstanze, stumpf
 Hook punch, blunt nose
 Pinza cortante, de nariz roma

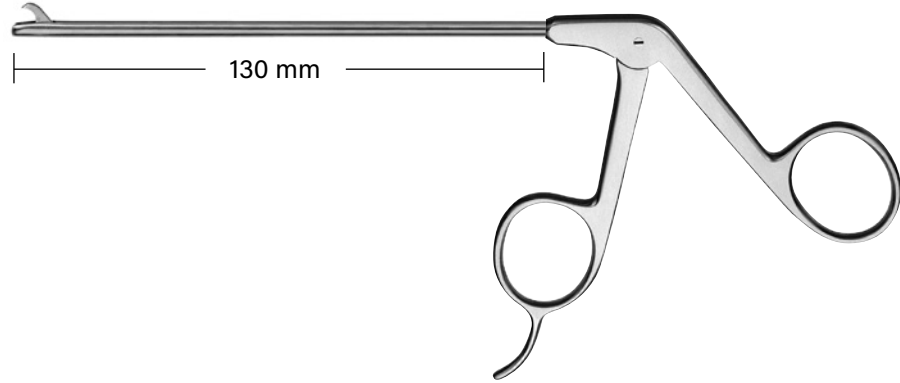

Hakenstanze, stumpf
 Hook punch, blunt nose
 Pinza cortante, de nariz roma

gerade / straight / recta

3,4 mm Ø
 cutting size 5 x 1,6

2,8 mm Ø
 cutting size 4 x 1,2

R441-034130-000

R441-028130-000



30°

Schaft gebogen / shaft curved
 vaina curva:

rechts / right / derecha

R441-034130-030

R441-028130-030

links / left / izquierda

R441-034130-130

R441-028130-130



45°

rechts / right / derecha

R441-034130-045

R441-028130-045

links / left / izquierda

R441-034130-145

R441-028130-145



7°

aufwärts / upwards
 hacia arriba

R441-034130-007

R441-028130-007



abwärts / downwards
 hacia abajo

R441-034130-107

R441-028130-107



15°

aufwärts / upwards
 hacia arriba

R441-034130-015

R441-028130-015



abwärts / downwards
 hacia abajo

R441-034130-115

R441-028130-115

Hakenstanze, stumpf 15°
 Hook punch, blunt nose 15°
 Pinza cortante, de nariz roma 15°

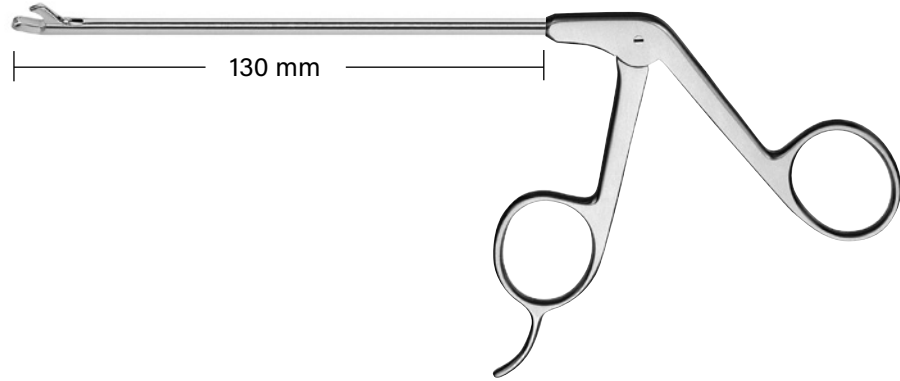

3,4 mm Ø
 cutting size 5 x 1,6

2,8 mm Ø
 cutting size 4 x 1,2

Hakenstanze, stumpf
 Hook punch, blunt nose
 Pinza cortante, de nariz roma



gerade / straight / recta

R441-034130-400

R441-028130-400



30°

Schaft gebogen / shaft curved
 vaina curva:

rechts / right / derecha

R441-034130-430

R441-028130-430

links / left / izquierda

R441-034130-630

R441-028130-630



45°

rechts / right / derecha

R441-034130-445

R441-028130-445

links / left / izquierda

R441-034130-645

R441-028130-645



7°

aufwärts / upwards
 hacia arriba

R441-034130-407

R441-028130-407



abwärts / downwards
 hacia abajo

R441-034130-607

R441-028130-607



15°

aufwärts / upwards
 hacia arriba

R441-034130-415

R441-028130-415



abwärts / downwards
 hacia abajo

R441-034130-615

R441-028130-615

Stanze, gezahnt, slim
 Punch, serrated, slim
 Pinza cortante aserrada, slim

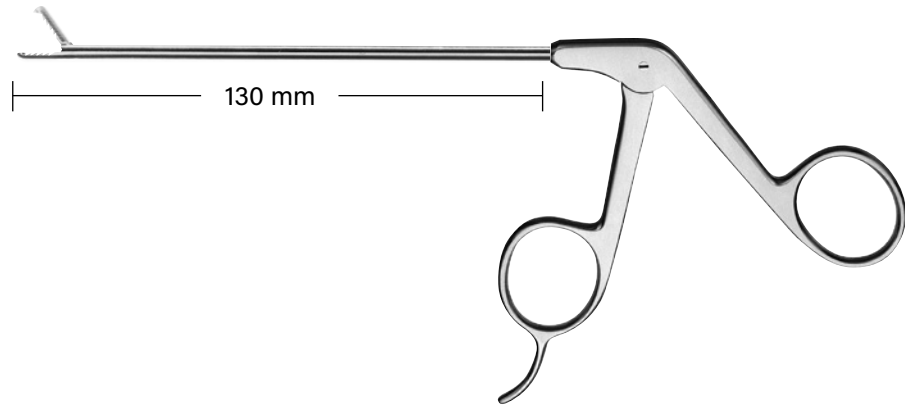

Stanze, gezahnt
 Punch, serrated
 Pinza cortante aserrada

gerade / straight / recta

3,4 mm Ø
 cutting size 6 x 2

2,8 mm Ø
 cutting size 5 x 1,6

R442-034130-000

R442-028130-000



30°

Schaft gebogen / shaft curved
 vaina curva:

rechts / right / derecha

links / left / izquierda

R442-034130-030

R442-028130-030

R442-034130-130

R442-028130-130



45°

rechts / right / derecha

links / left / izquierda

R442-034130-045

R442-028130-045

R442-034130-145

R442-028130-145



7°

aufwärts / upwards
 hacia arriba

R442-034130-007

R442-028130-007



abwärts / downwards
 hacia abajo

R442-034130-107

R442-028130-107



15°

aufwärts / upwards
 hacia arriba

R442-034130-015

R442-028130-015











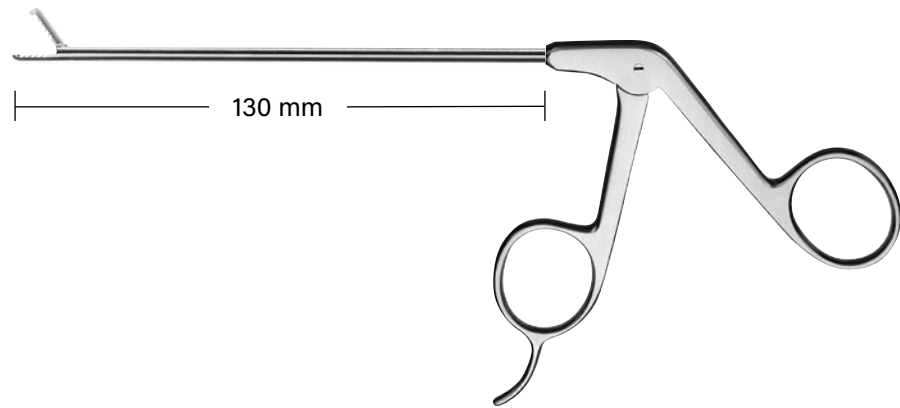

abwärts / downwards
 hacia abajo

R442-034130-115

R442-028130-115

Stanze, gezahnt „Duck“ Form
 Punch, serrated, „Duck“ shaped
 Pinza cortante, aserrada, pico de pato



		3,4 mm Ø cutting size 6 x 2	2,8 mm Ø cutting size 5 x 1,6
	Stanze, gezahnt „Duck“ Form 15° Punch, serrated, „Duck“ shaped 15° Pinza cortante, aserrada, pico de pato 15° gerade / straight / recta	R441-034130-200	R441-028130-200
	Schaft gebogen / shaft curved vaina curva: rechts / right / derecha	R441-034130-230	R441-028130-230
	links / left / izquierda	R441-034130-330	R441-028130-330
	rechts / right / derecha	R441-034130-245	R441-028130-245
	links / left / izquierda	R441-034130-345	R441-028130-345
	aufwärts / upwards hacia arriba	R441-034130-207	R441-028130-207
	abwärts / downwards hacia abajo	R441-034130-307	R441-028130-307
	aufwärts / upwards hacia arriba	R441-034130-215	R441-028130-215
	abwärts / downwards hacia abajo	R441-034130-315	R441-028130-315

Stanze, gezahnt, lang
 Punch, serrated, long
 Pinza cortante, larga

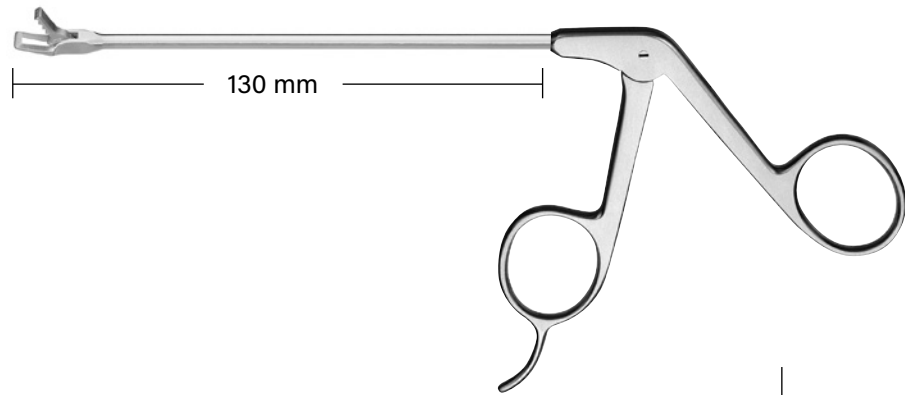

Standard



Duck

gerade / straight / recta



30°

Schaft gebogen / shaft curved
 vaina curva:

rechts / right / derecha

links / left / izquierda

Standard

Duck" Form, 15°
 Duck" shaped, 15°
 pico de pato, 15°

3,4 mm Ø
 cutting size 6 x 3,5

R444-034130-000

3,4 mm Ø
 cutting size 6 x 3,5

R444-034130-200



R444-034130-030

R444-034130-230

R444-034130-130

R444-034130-330



45°

rechts / right / derecha

links / left / izquierda

R444-034130-045

R444-034130-245

R444-034130-145

R444-034130-345



7°

aufwärts / upwards
 hacia arriba

abwärts / downwards
 hacia abajo

R444-034130-007

R444-034130-207

R444-034130-107

R444-034130-307



15°

aufwärts / upwards
 hacia arriba

abwärts / downwards
 hacia abajo

R444-034130-015

R444-034130-215

R444-034130-115

R444-034130-315

Stanze, gezahnt, breit
Punch, serrated, wide
Pinza cortante, aserrada, ancha

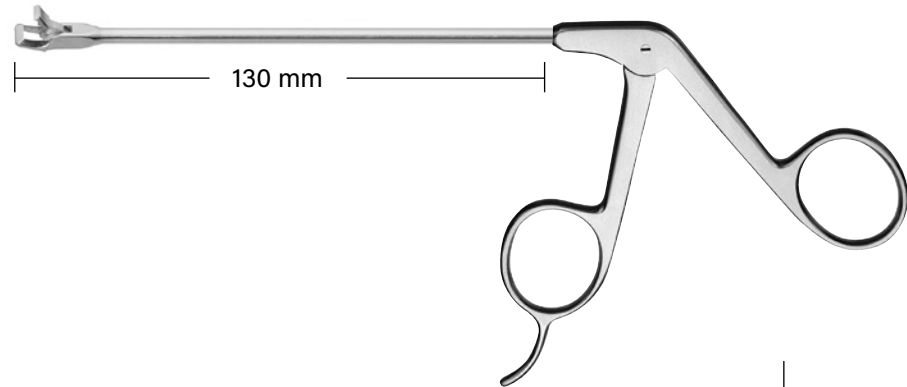

Standard



Duck

gerade / straight / recta



30°

Schaft gebogen / shaft curved
vaina curva:

rechts / right / derecha

links / left / izquierda

Standard

Duck" Form, 15°
Duck" shaped, 15°
pico de pato, 15°

3,4 mm Ø
cutting size 4 x 4

R443-034130-000

3,4 mm Ø
cutting size 4 x 4

R443-034130-200

R443-034130-030

R443-034130-230

R443-034130-130

R443-034130-330



45°

rechts / right / derecha

links / left / izquierda

R443-034130-045

R443-034130-245

R443-034130-145

R443-034130-345

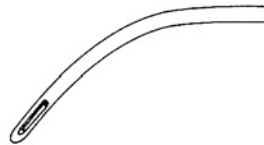

7°

aufwärts / upwards
hacia arriba

abwärts / downwards
hacia abajo

R443-034130-007

R443-034130-207

R443-034130-107

R443-034130-307



15°

aufwärts / upwards
hacia arriba

abwärts / downwards
hacia abajo

R443-034130-015

R443-034130-215

R443-034130-115

R443-034130-315

Stanze, gezahnt, extra breit
 Punch, serrated, extra wide
 Pinza cortante, aserrada, extra ancha

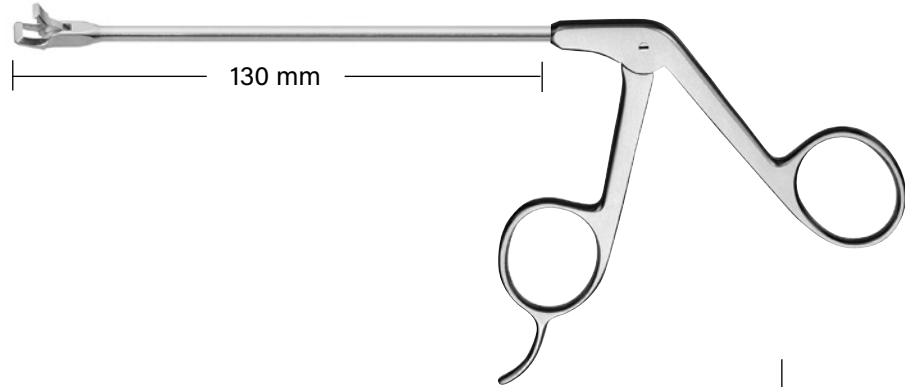

Standard



Duck

gerade / straight / recta

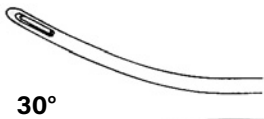

30°

Schaft gebogen / shaft curved
 vaina curva:

rechts / right / derecha

links / left / izquierda

Standard

Duck" Form, 15°
 Duck" shaped, 15°
 pico de pato, 15°

3,4 mm Ø
 cutting size 5 x 4,5

3,4 mm Ø
 cutting size 5 x 4,5

R446-034130-000

R446-034130-200

R446-034130-030

R446-034130-230

R446-034130-130

R446-034130-330



45°

rechts / right / derecha

links / left / izquierda

R446-034130-045

R446-034130-245

R446-034130-145

R446-034130-345

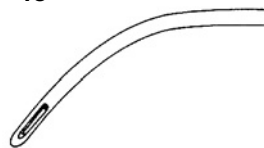

7°

aufwärts / upwards
 hacia arriba

abwärts / downwards
 hacia abajo

R446-034130-007

R446-034130-207

R446-034130-107

R446-034130-307

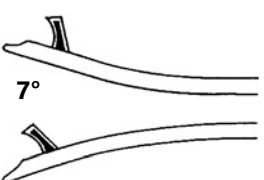

15°

aufwärts / upwards
 hacia arriba

abwärts / downwards
 hacia abajo

R446-034130-015

R446-034130-215

R446-034130-115

R446-034130-315

Mikro-Stanze
Slender Punch
Micro pinza cortante

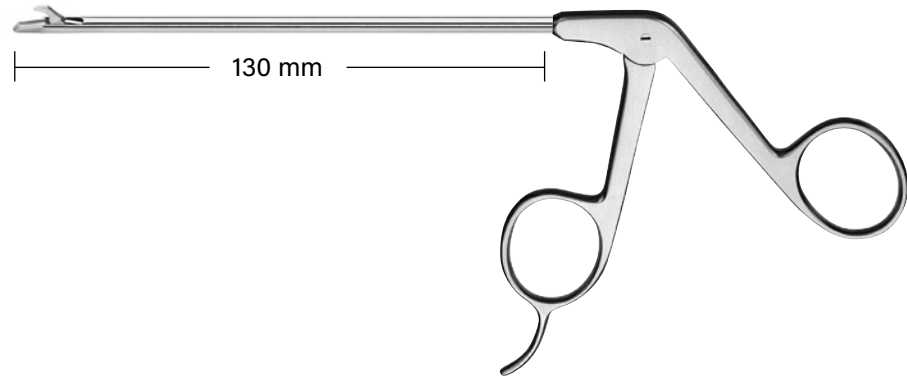

3,4 mm Ø
cutting size 0,8 x 5.5 mm



gerade / straight / recta

R447-034130-000



30°

Schaft gebogen / shaft curved
vaina curva:

rechts / right / derecha

R447-034130-030

links / left / izquierda

R447-034130-130



45°

rechts / right / derecha

R447-034130-045

links / left / izquierda

R447-034130-145



7°

aufwärts / upwards
hacia arriba

R447-034130-007

abwärts / downwards
hacia abajo

R447-034130-107

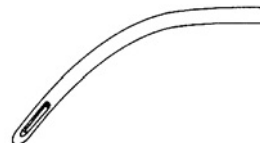

15°

aufwärts / upwards
hacia arriba

R447-034130-015

abwärts / downwards
hacia abajo

R447-034130-115

Stanze oval
 Oval Punch
 Pinza ovalada

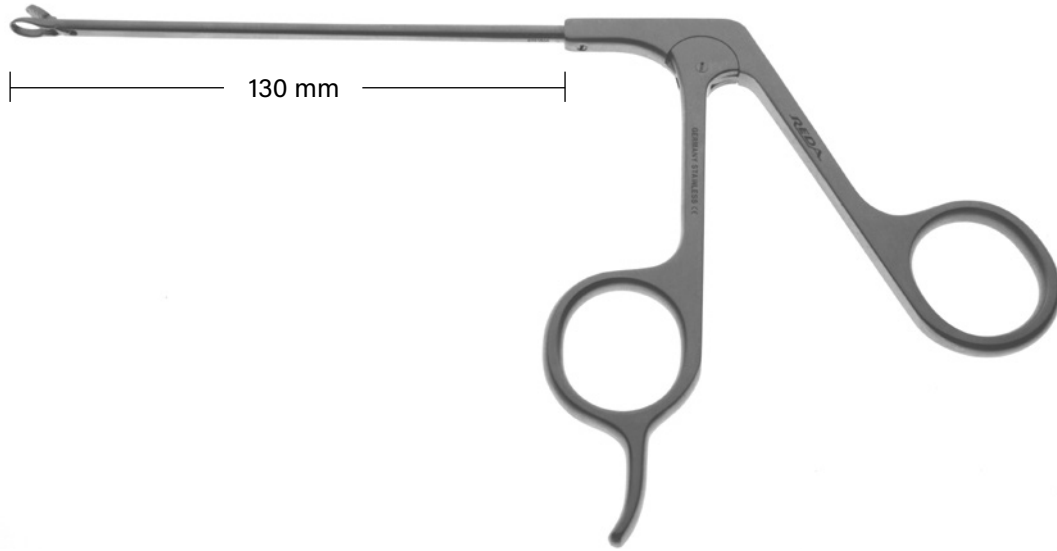

gerade / straight / recta

3,4 mm Ø
 cutting size 4,4 mm

R448-034130-000

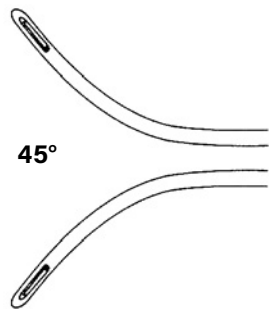

45°

rechts / right / derecha

R448-034130-045

links / left / izquierda

R448-034130-145



15°

aufwärts / upwards / hacia arriba

R448-034130-015

aufgewinkelt / angled up / angulada hacia arriba

R448-034130-200

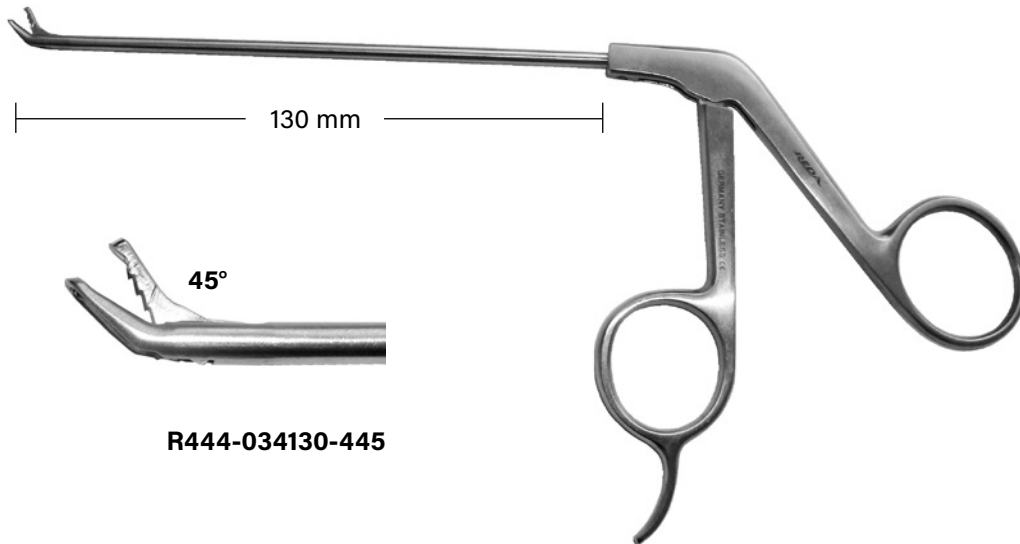

R444-034130-445

Biopsie-Stanze, 45° nach oben schneidend, 3,4 mm Ø
Biopsy punch, 45° upcurved cutting, 3,4 mm Ø
Pinza para biopsia, 45° corte hacia arriba, 3,4 mm Ø



cutting size 3,8 x 2,4

Antrumstanze durchschneidend, 3,5 mm Ø, 130 mm Nutzlänge
Antrum punch through cutting, 3,5 mm Ø, 130 mm working length
Pinza Antrum cortante, 3,5 mm Ø, largo útil de 130 mm

rechts / right / derecha



R448-035130-600

links / left / izquierda

R448-035130-800

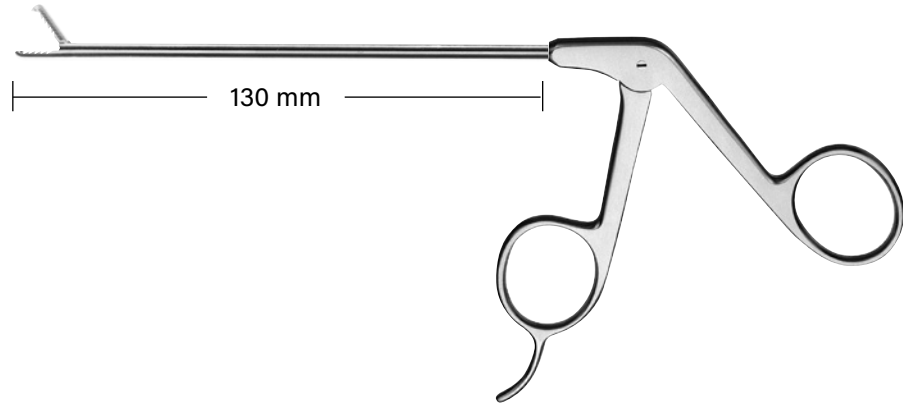
Biopsie-Stanze, seitlich schneidend 3,4 mm Ø
 Biopsy punch, side-biter 3.4 mm Ø
 Pinza para biopsia, corte lateral 3,4 mm Ø



		mit Schippe scoope nose de nariz aguda	stumpf blunt nose de nariz roma
Maulteil gewinkelt / jaw angled / boca angulada:			
 <p>90°</p> <p>cutting size 5 x 1.6 mm</p>	rechts / right / derecha	R440-034130-590	R441-034130-590
	links / left / izquierda	R440-034130-790	R441-034130-790
 <p>45°</p> <p>cutting size 3,5 x 1.6 mm</p>	rechts / right / derecha	R440-034130-545	R441-034130-545
	links / left / izquierda	R440-034130-745	R441-034130-745

Biopsie-Stanze, seitlich schneidend, breit
 Biopsy punch, side-biter, wide
 Pinza para biopsia, corte lateral, ancha

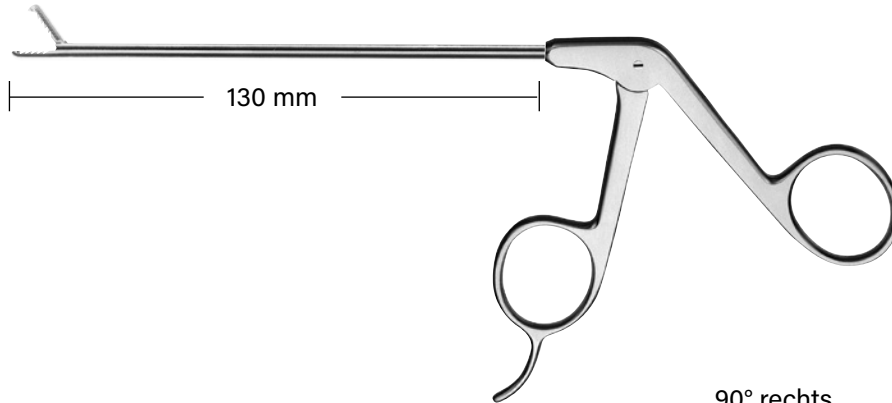

gerade / straight / recta



30°

Schaft gebogen / shaft curved
 vaina curva:

rechts / right / derecha

links / left / izquierda

90° rechts
 90° right
 90° derecha

90° links
 90° left
 90° izquierda

3,4 mm Ø
 cutting size 4 x 4

3,4 mm Ø
 cutting size 4 x 4

R443-034130-590

R443-034130-790

R443-034130-530

R443-034130-730

R443-034130-630

R443-034130-830



45°

rechts / right / derecha

links / left / izquierda

R443-034130-545

R443-034130-745

R443-034130-645

R443-034130-845



7°

aufwärts / upwards
 hacia arriba

R443-034130-507

R443-034130-707



abwärts / downwards
 hacia abajo

R443-034130-607

R443-034130-807



15°

aufwärts / upwards
 hacia arriba

R443-034130-515

R443-034130-715



abwärts / downwards
 hacia abajo

R443-034130-615

R443-034130-815

Rotationszange, Schnittbreite 3,4 mm
Rotary punch, cutting size 3,4 mm
Pinza rotatoria, corte de 3,4 mm

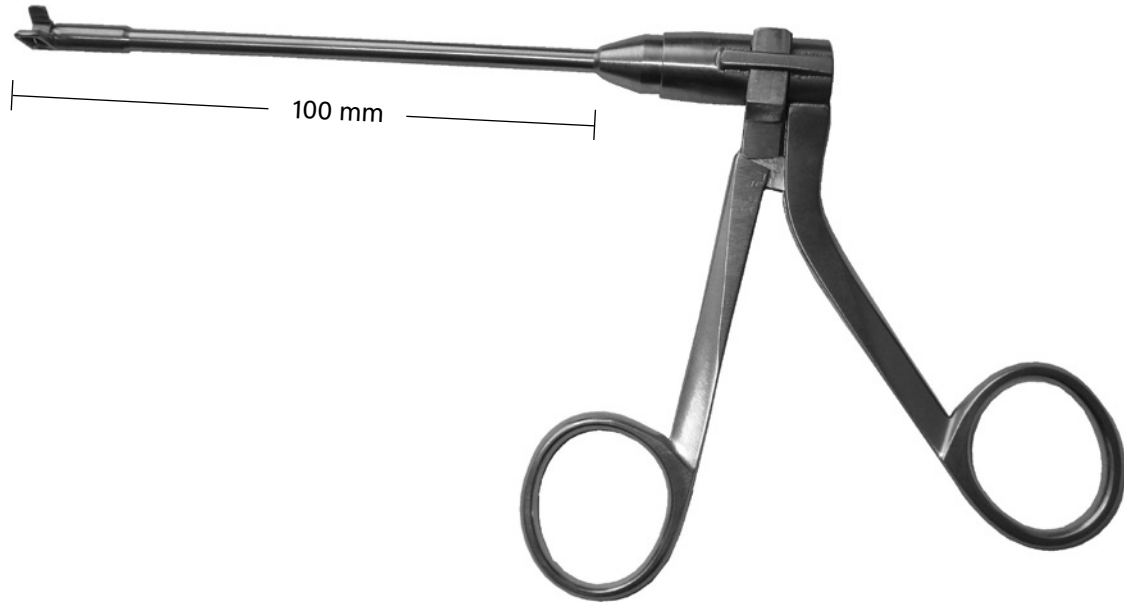

Rotationszange für große Schnitte
100 mm Nutzlänge, Ringgriff Standard

Rotary punch for big cutting size
100 mm working length, grip handle

Pinza rotatoria, para cortes grandes,
largo útil de 100 mm, mango de anillo



90° rechts / right
90° hacia la derecha

R449-035100-090





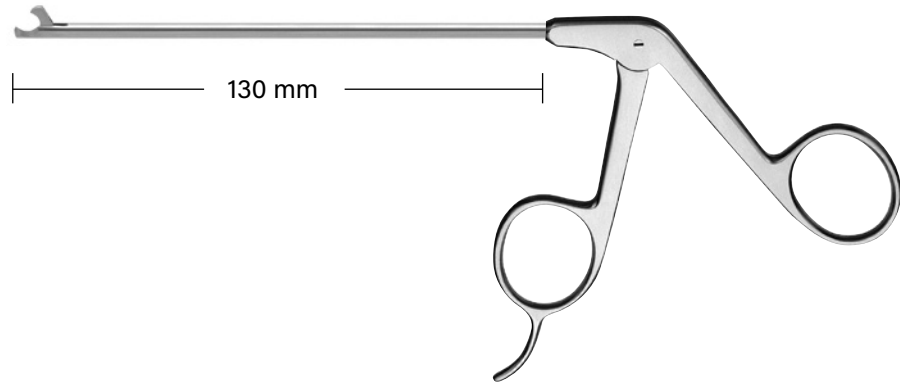

90° links / left
90° hacia la izquierda

R449-035100-190

Hakenschere
Hook scissors
Tijera en forma de gancho

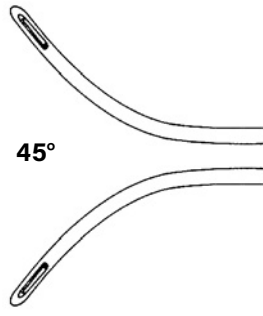

		3,4 mm Ø	2,8 mm Ø
	Hakenschere Hook scissors Tijera en forma de gancho		
	gerade / straight / recta	R450-034130-000	R450-028130-000
	Schaft gebogen / shaft curved vaina curva:		
30°	rechts / right / derecha	R450-034130-030	R450-028130-030
	links / left / izquierda	R450-034130-130	R450-028130-130
			
45°	rechts / right / derecha	R450-034130-045	R450-028130-045
	links / left / izquierda	R450-034130-145	R450-028130-145
	Maulteil gewinkelt / jaw angled boca angulada:		
45°	rechts / right / derecha	R450-034130-245	
	links / left / izquierda	R450-034130-345	

Schere gezahnt
Scissors serrated
Tijera dentada

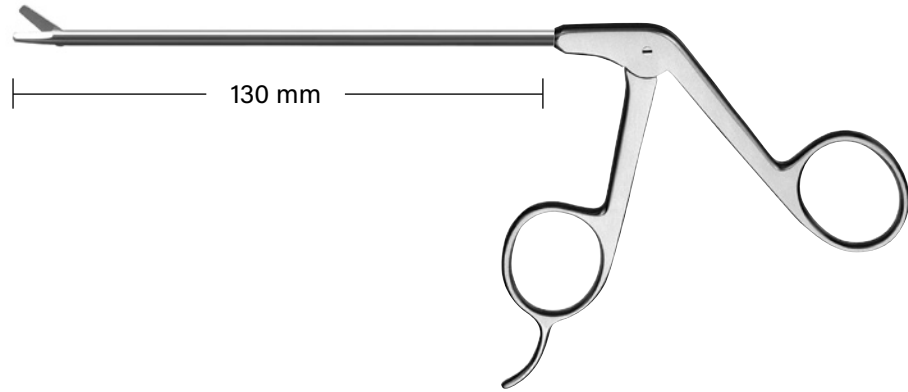

3,4 mm Ø



Schere gezahnt
Scissors serrated
Tijera dentada

gerade / straight / recta

R451-034130-000

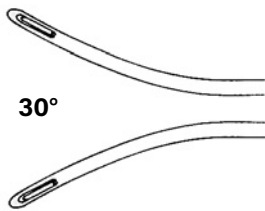

30°

Schaft gebogen / shaft curved
vaina curva:

rechts / right / derecha

R451-034130-030

links / left / izquierda

R451-034130-130

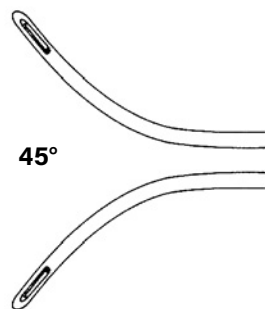

45°

rechts / right / derecha

R451-034130-045

links / left / izquierda

R451-034130-145

Faßzangen
Grasper
Pinzas de agarre

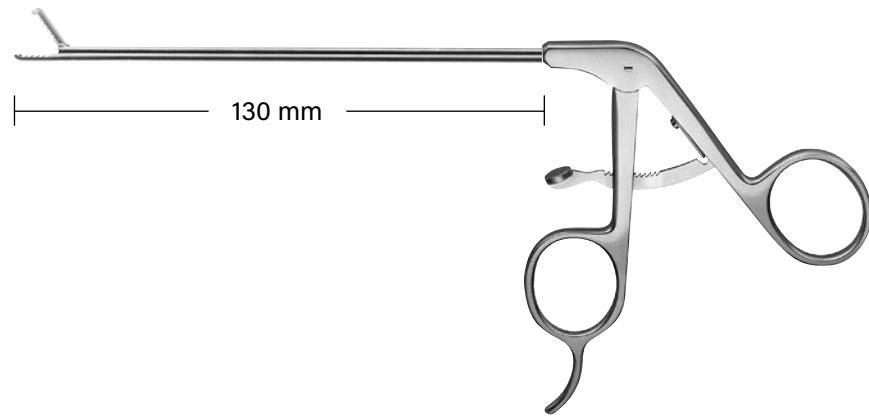

Greifzange
Alligator grasping Forceps
Pinza de agarre

3,4 mm Ø **R430-034130-000**
2,8 mm Ø **R430-028130-000**

Greifzange mit Sperre
Alligator grasping forceps, with ratchet
Pinza de agarre con cremallera

3,4 mm Ø **R431-034130-000**
2,8 mm Ø **R431-028130-000**



Faßzange mit Mauszahn
Alligator grasping forceps with mouse teeth
Pinza de agarre con diente de ratón

3,4 mm Ø **R432-034130-000**
2,8 mm Ø **R432-028130-000**

Faßzange, Mauszahn und Sperre
Alligator grasping forceps with mouse teeth and ratchet
Pinza de agarre con diente de ratón y cremallera

3,4 mm Ø **R433-034130-000**
2,8 mm Ø **R433-028130-000**



Faß-Biopsie-Zange
Grasping and biopsy forceps
Pinza de agarre y biopsia

3,4 mm Ø **R434-034130-000**
2,8 mm Ø **R434-028130-000**

Faß-Biopsie-Zange mit Sperre
Grasping and biopsy forceps with ratchet
Pinza de agarre y biopsia con cremallera

3,4 mm Ø **R435-034130-000**
2,8 mm Ø **R435-028130-000**

Biopsie-Zange
Biopsy forceps
Pinza de biopsia

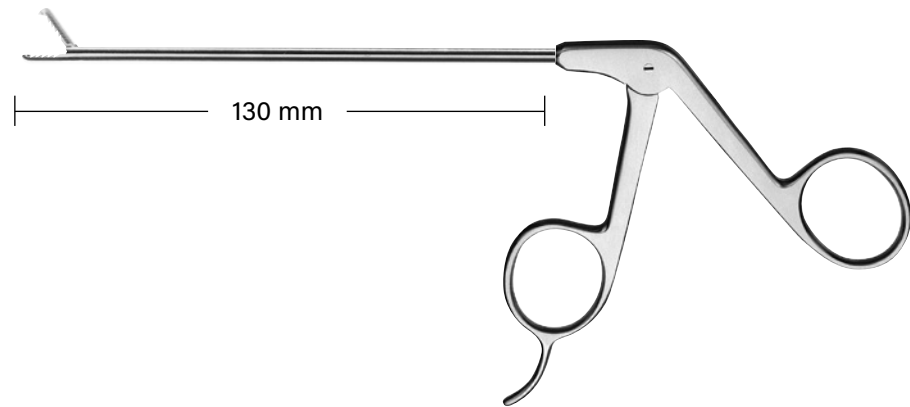

Biopsiezange
Biopsy forceps
Pinza de biopsia

3,4 mm Ø **R436-034130-000**
2,8 mm Ø **R436-028130-000**



Biopsiezange, mit Dorn
Biopsy forceps, with spike
Pinza de biopsia, con espina

3,4 mm Ø **R436-034130-001**
2,8 mm Ø **R436-028130-001**

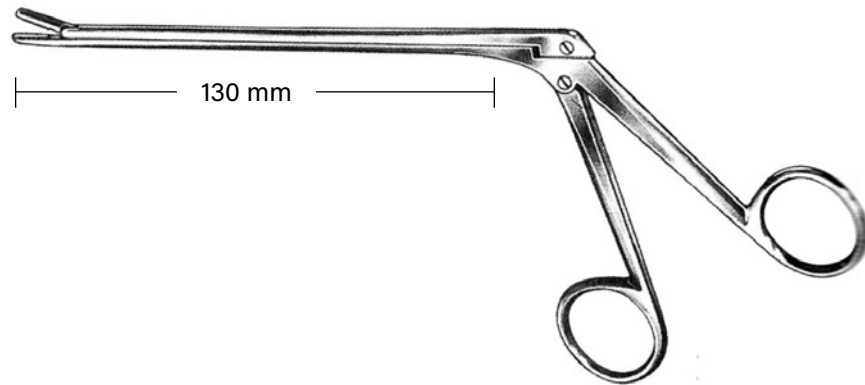

Meniskus-Faßzange kräftig
Meniscus grasping forceps, strong
Pinza de agarre para el menisco, fuerte

2 x 10 mm **R436-042150-210**
3 x 10 mm **R436-042150-310**
4 x 10 mm **R436-042150-410**

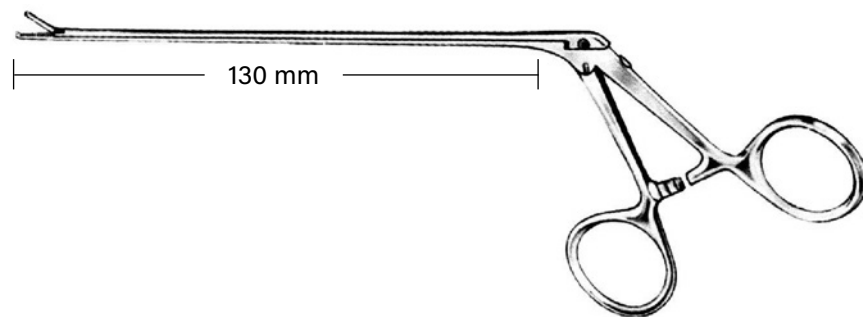

Mini-Faß-Zange mit Mauszahn und Sperre, 2,2 mm Ø
Mini grasper with mouse teeth and ratchet, 2,2 mm Ø
Pinza de agarre, modelo mini, con diente de ratón y cremallera, 2,2 mm Ø

R437-022130-000

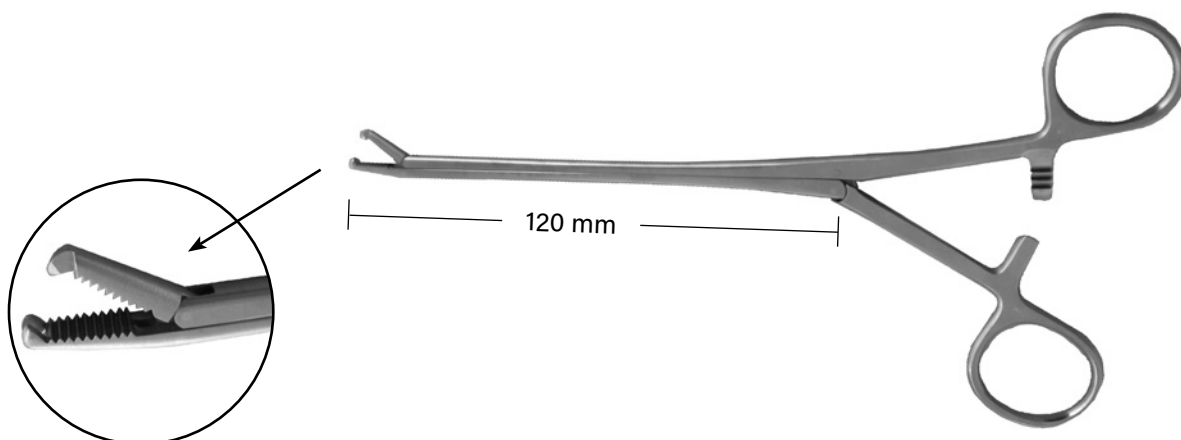

Meniskusretraktor gerade mit Mauszahn und Sperre
Meniscus retractor straight with mouse teeth and ratchet
Retractor de menisco, recto, con diente de ratón y cremallera

R438-035130-000

Fadenzangen, ø 3,4 mm
 Ligature forceps, ø 3,4 mm
 Pinzas para ligadura, ø 3,4 mm

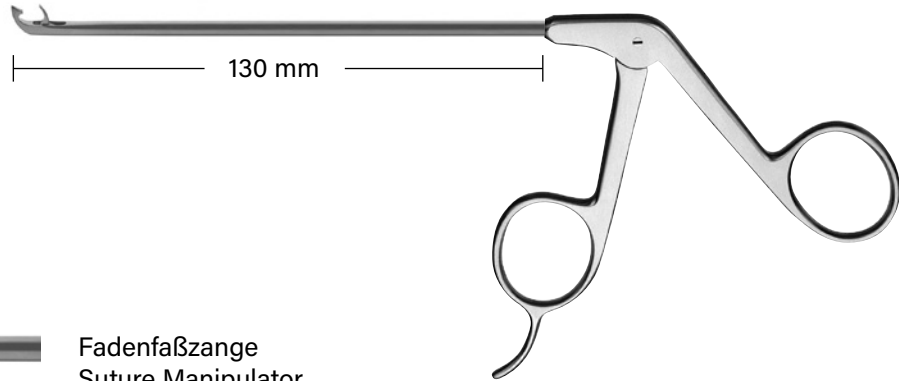

Fadenfaßzange
 Suture Manipulator
 pinza de agarre para sutura



gerade / straight / recta

R439-034130-000

15°

aufwärts / upwards
 hacia arriba

R439-034130-015



rechts / right / derecha

R439-034130-045

45°

links / left / izquierda

R439-034130-145



Fadenfänger gerade
 Suture grasper
 pinza de agarre recta

R439-034130-100



aufwärts / upwards
 hacia arriba

R439-034130-115

15°



Faden Punch gerade
 Suture punch straight
 pinza de agarre recta

R439-034130-200



45° aufwärts / upwards
 45° hacia arriba

R439-034130-300



10° aufwärts / upwards
 10° hacia arriba

R439-034130-310

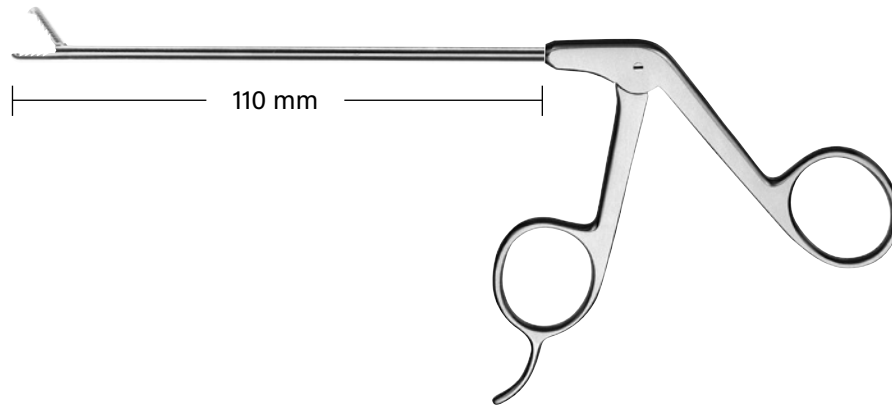

Zange mit Doppellöfel, 2 mm Ø
Forceps with double spoon, 2 mm Ø
Pinza con cucharilla doble, 2 mm Ø

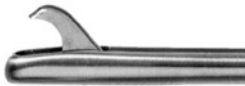
R480-020110-000

Zange durchschneidend, 2 mm Ø
Forceps cutting through, 2 mm Ø
Pinza cortante, 2 mm Ø

R481-020110-000

Schere, 2 mm Ø
Scissors, 2 mm Ø
Tijera, 2 mm Ø

R485-020110-000

Faß-Biopsie-Zange, 2 mm Ø
Grasping and biopsy forceps, 2 mm Ø
Pinza de agarre y biopsia, 2 mm Ø

R486-020110-000

Greif-Zange, 2 mm Ø
Grasping Forceps, 2 mm Ø
Pinza de agarre, 2 mm Ø

R487-020110-000



Hakensonde graduiert
Hook probe graduated
Gancho explorador graduado
3 mm
5 mm

R490-030110-03
R490-030110-05



Skalpelmesser
Scalpel knife
Cuchillo de bisturí

R490-030110-11



Hakenmesser
Hook knife
Cuchillo en forma de gancho

R490-030110-12



Messer retrograd
Knife, retrograde
Cuchillo retrógrado

R490-030110-13

Banana-Messer
Banana knife
Cuchillo en forma de plátano



glatt / smooth / liso

R490-030110-14



gezahnt / serrated / dentado

R490-030110-15



Rosettenmesser
Rosette knife
Cuchillo en forma de roseta

R490-030110-16



Meniskotom nach Smillie
Smillie knife
Meniscótomo de Smillie

3 mm
5 mm
7 mm

R490-030110-43
R490-030110-45
R490-030110-47



Messer sichelförmig
Sickle knife
Cuchillo en forma de hoz

R490-030110-17



Löffel, 3 mm Ø
Spoon, 3 mm Ø
Cucharilla, 3 mm Ø

R490-030110-21



Ring-Kürette
Ring curette
Cureta en forma de anillo

3 mm Ø
5 mm Ø
7 mm Ø

R490-030110-31
R490-030110-32
R490-030110-33



Knorpelfeile, fein
Cartilage file, fine
Lima para cartilago, fina

R490-030110-51



Knorpelfeile, grob
Cartilage file, coarse
Lima para cartilago, gruesa

R490-030110-52

Hand-Instrumente, zweiteilig
 Hand instruments, two parts
 Instrumentos manuales, de dos partes



Hakensonde graduiert
 Hook probe graduated
 Gancho explorador graduado

2,5 mm
 3,5 mm

R492-030110-03
R492-030110-04

Hakensonde spitz
 Palpation hook pointed
 Gancho explorador agudo

R492-030110-00



Skalpellmesser
 Scalpel knife
 Cuchillo de bisturí

R492-030110-11



Hakenmesser
 Hook knife
 Cuchillo en forma de gancho

R492-030110-12



Messer retrograd
 Knife retrograde
 Cuchillo retrógrado

R492-030110-13

Banana-Messer
 Banana knife
 Cuchillo en forma de plátano



glatt / smooth / liso

R492-030110-14



gezahnt / serrated / dentado

R492-030110-15



Rosettenmesser
 Rosette knife
 Cuchillo en forma de roseta

R492-030110-16



Griff allein mit Spannzange
Handle alone with wrench
Mango solo con adaptador de fijación

R492-000000-000



Meniskotom nach Smillie
Smillie knife
Meniscótomo de Smillie

3 mm

R492-030110-43

5 mm

R492-030110-45

7 mm

R492-030110-47



Messer sichelförmig
Sickle knife
Cuchillo en forma de hoz

R492-030110-17



Löffel, 3 mm Ø
Spoon, 3 mm Ø
Cucharilla, 3 mm Ø

R492-030110-21



Ring-Kürette, 3 mm Ø
Ring curette, 3 mm Ø
Cureta en forma de anillo, 3 mm Ø

R492-030110-31



Ring-Kürette, 7 mm Ø
Ring curette, 7 mm Ø
Cureta en forma de anillo, 7 mm Ø

R492-030110-32



Knorpelfeile, fein
Cartilage file, fine
Lima para cartilago, fina

R492-030110-51



Knorpelfeile, grob
Cartilage file, coarse
Lima para cartilago, gruesa

R492-030110-52



Meniskotom nach Smillie
Smillie meniscotome
Meniscótomo de Smillie

3 mm
5 mm

R494-030110-43
R494-030110-45



Messer sichelförmig
Sickle knife
Cuchillo en forma de hoz

R494-030110-17



Löffel, 3 mm Ø
Spoon 3 mm Ø
Cucharilla, 3 mm Ø

R494-030110-21



Ring-Kürette, 3 mm Ø
Ring curette, 3 mm Ø
Cureta en forma de anillo, 3 mm Ø

R494-030110-31



Hakensonde
Hook probe
Gancho explorador

3,5 mm graduiert / graduated / graduado
4 mm

R494-030110-03
R494-030110-04



Skalpellmesser
Scalpel knife
Cuchillo de bisturí

R494-030110-11



Hakenmesser
Hook knife
Cuchillo en forma de gancho

R494-030110-12



Messer retrograd
Knife, retrograde
Cuchillo retrógrado

R494-030110-13

Banana-Messer
Banana knife
Cuchillo en forma de plátano



glatt / smooth / liso

R494-030110-14



gezahnt / serrated / dentado

R494-030110-15



Rosettenmesser
Rosette knife
Cuchillo en forma de roseta

R494-030110-16



Knorpelfeile, fein
Cartilage file, fine
Lima para cartilago, fina

R494-030110-51



Knorpelfeile, grob
Cartilage file, coarse
Lima para cartilago, gruesa

R494-030110-52

Inflow-Kanüle
Inflow cannula
Cánula Inflow



Spülkanüle mit 2 seitlichen Löchern, LL-Anschluß, 4,5 mm Ø, 8,3 cm
Irrigation cannula with 2 holes, LL-connection, 4.5 mm Ø, 8.3 cm
Canula de irrigación con dos perforaciones laterales, conexión LL, 4,5 mm Ø, 8,3 cm

R470-045083-000

scharfer Obturator
sharp obturator
obturador agudo

R470-045083-001

stumpfer Obturator
blunt obturator
obturador romo

R470-045083-002

Spüladapter mit Schlaucholive
Irrigation adapter with tube connection
Adaptador con conexión al tubo

R470-045000-000

	3,2 mm Ø	4,5 mm Ø
Spülsatz, komplett mit Kanüle und Obturatoren Aspiration cannula complete with cannula and obturators Canula de irrigación completa con canula e obturadores	R471-032070-199	R471-045070-199

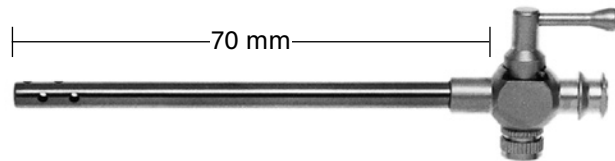

Kanüle für Spülung mit Hahn, LL-Anschluß, 7 cm lang Cannula for irrigation with stop cock LL-connection, 7 cm length Cánula de irrigación con llave, conexión LL, largo útil de 7 cm	R471-032070-000	R471-045070-000
--	------------------------	------------------------



scharfer Obturator sharp obturator obturador agudo	R471-032070-024	R471-045070-024
--	------------------------	------------------------



stumpfer Obturator blunt obturator obturador romo	R471-032070-003	R471-045070-003
---	------------------------	------------------------



Kanüle für Spülung, LL-Anschluß, 3,2 mm Ø, 7 cm lang Cannula for irrigation, LL-connection, 3,2 mm Ø, 7 cm length Cánula de irrigación, conexión LL, 3,2 mm Ø, largo útil de 7 cm	R472-032070-000
---	------------------------

Endoskope für Arthroskopie
Endoscopes for Arthroscopy
Endoscopios para artroscopía

Ø 1,9 mm

Arthroskop, autoklavierbar mit integrierter Faser zur Beleuchtung für diagnostische und operative Eingriffe: kleine Gelenke

Arthroscope, autoclavable, with integrated fiber optic for illumination, for diagnostic and operation: small joint

Artroscopios (ópticas) autoclavables con fibroptica incorporado para intervenciones diagnósticas y operativas: articulaciones pequeñas

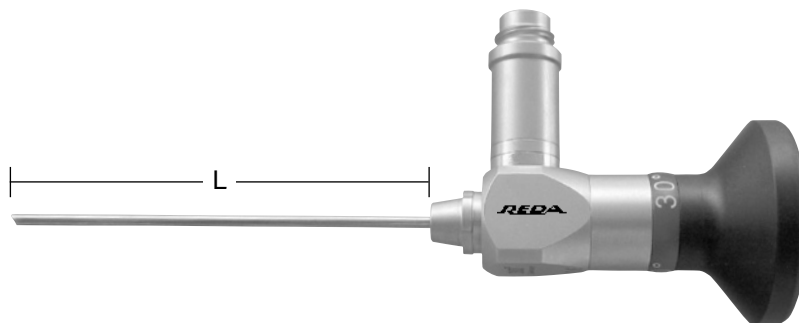

69 mm

102 mm

R400-019069-030

R400-019102-030

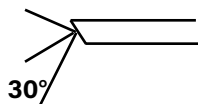

Vorausblick
Foroblique vision
ángulo de

Instrumente für 2. Einstich
Instruments for 2nd puncture
Instrumentos para la segunda perforación

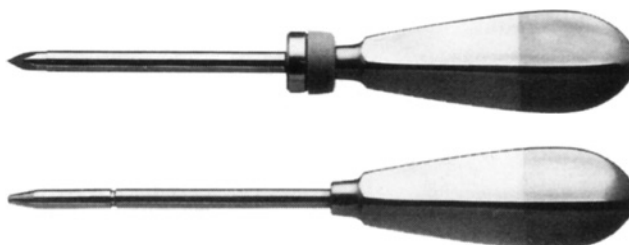

Trokarhülse mit scharfem und stumpfem Obturator, 2,5 mm Ø
Trocar sleeve with sharp and blunt obturator, 2,5 mm Ø
Tubo con obturadores agudos y romos, 2,5 mm Ø

R490-025110-43

Farbcode für Blickrichtung:
Colour coding for indication of direction of view:
Indicación a color para definir la dirección de la vista:

grün / green / verde	= 0°
rot / red / rojo	= 30°
orange / orange / naranja	= 45°
gelb / yellow / amarillo	= 70°

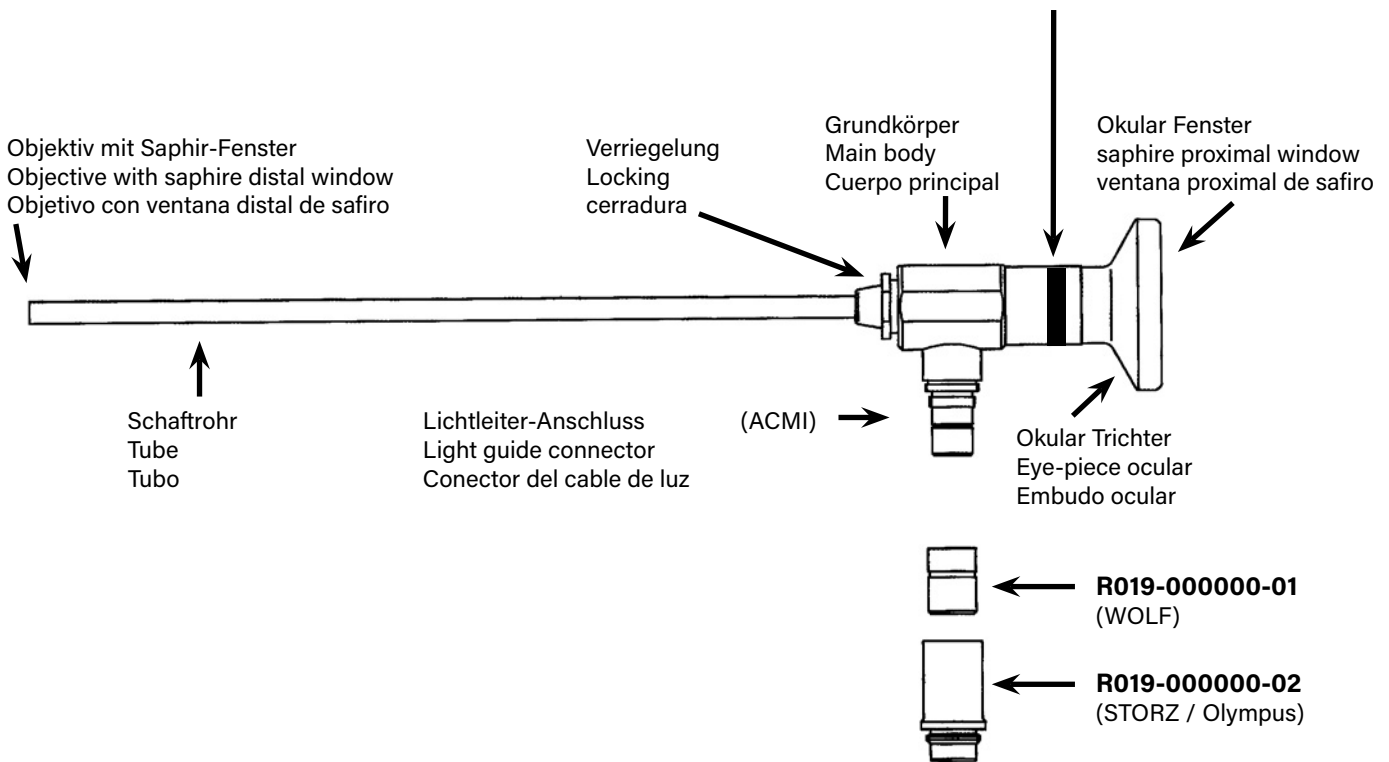

Scope Pak klein für Arthroskop
Scope pak small for one Arthroscope
Caja pequeña para Artroscofio

R019-9312

Zubehör
Accessories
Accesorios



Antibeslagmittel Ultra Stop 25 ml unsteril in Pipettenflasche
Anti Fog liquid Ultra Stop 25 ml non sterile
Agente antivano ultra stop 25 ml, no esteril en frasco de pipeta

R019-000000-025

Antibeslagmittel Ultra Stop steril 30 ml in Einstichflasche
Anti Fog liquid Ultra Stop sterile incision bottle 30 ml
Agente antivano ultra stop, esteril 30 ml en frasco de pinchazo

R019-000000-030



Reinigungsmittel, Tube mit 6gr. f. distale u. proximale Linsen u. Fiberglas-Flächen von Endoskopen
Cleaning waste, 6gr. f. distal and proximal windows and fiber optic port of endoscopes
Agente de limpieza, tubo con 6gr para ventanas y optical distales y proximales

98002-06

Container Typen und Dimensionen
Container models and dimensions
Modelos de contenedores y medidas

285 x 280 x 200 mm

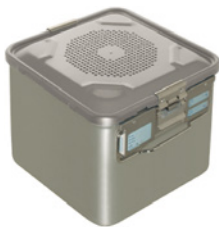

Deckel gelocht
 Boden ungelocht
 Perforated lid
 Unperforated bottom
 Tapa perforada
 Cuerpo sin perforación



Deckel gelocht
 Boden gelocht
 Perforated lid
 Perforated bottom
 Tapa perforada
 Cuerpo perforado



Sicherheitsdeckel
 Boden ungelocht
 Safety lid
 Unperforated bottom
 Tapa de seguridad
 Cuerpo sin perforación



Sicherheitsdeckel
 Boden gelocht
 Safety lid
 Perforated bottom
 Tapa de seguridad
 Cuerpo perforado



silber
 gelb
 rot
 blau
 grün

R 310.20
R 320.20
R 330.20
R 340.20
R 350.20

R 311.20
R 321.20
R 331.20
R 341.20
R 351.20

R 312.20
R 322.20
R 332.20
R 342.20
R 352.20

R 313.20
R 323.20
R 333.20
R 343.20
R 353.20

Lagerungs- und Sterilisierack
Storage- and sterilization rack
Soporto para almacenaje y esterilizacion



89258-25
 232x210x155 mm

für Arthroskopie Instrumente
 for arthroscopy instruments
 para instrumentos de atroscopia



Arthroscopic Shaver

- High quality arthroscopic shaver system
- Controlled by a wireless or cable footswitch.
- Efficient, light and ergonomic handpiece enhanced by a wide range of rotational speed.
- Designed to work with multi- and single-use shaver blades.

Features

- Outputs for two handpieces
- A handpiece with automatic or manual lock
- Clockwise, counterclockwise and oscillation handpiece rotation modes
- Three oscillation modes: light, medium and aggressive
- Controlled by a control unit panel or footswitch
- Automatic identification of a connected handpiece and set of previously used parameters
- Working with various shaver blades of well-known manufacturers

Benefits

- Wireless footswitch
- Ergonomic and autoclavable handpiece
- Protection against overloading of a handpiece
- Smooth and continuous work of the motor.
- Stable oscillation mode
- Fully controlled rotational and oscillation speed
- Disposable and multi-use shaver blades (with no use-limits)
- Non-volatile memory of recent settings
- Big and clear display
- Esthetic and modern design
- Multi-language menu (English, German, French, Polish, Russian and Turkish)

Technical parameters

SHAVER CONSOLE

RED-8002-10	Technical Data
Input voltage	100-240V AC
Frequency voltage	50/60Hz
External dimensions	D: 306 mm x W: 330 mm x H: 96 mm
Weight	5,1 kg
Ambient temperature	During operation: +10°C to +40°C During storage and transport: -20°C to +45°C
Max. relative humidity	During operation: 70% During storage and transport: 70%
Class of protection	Applied part - type B
CE Standard	EN60601-1; EN60601-1-2



HANDPIECE

RED-8008-11H	Technical Data
Length	185 mm / 188 mm
Weight	400 g / 410 g
Blades chuck	Manual locking
Speed range	800 - 8000 RPM (± 10%)
Oscillate cycle	Light (0,5 sec.), Medium (0,3 sec.), Aggressive (0,2 sec.)
Cable length	3m
Sterilization method	Steam sterilization 134°C
Ambient temperature	During operation: +10°C to +40°C During storage and transport: -20°C to +45°C
Max. relative humidity	During operation: 100% During storage and transport: 90%



FOOTSWITCHES

Cable	RED-8005-2F
Wireless	RED-8005B-3F
Technical Data	
Dimensions	D: 215 mm x W: 280 mm x H: 28 mm
Weight	2,45 kg / 2,2 kg
Cable length	3 m / Wireless (up to receiver)
Battery type	N/A / Lithium-polymer accumulator
Nominal battery charge	N/A / 1250 mAh
Charger	N/A / 5 V DC / 700 mA
Battery lifetime	N/A / > 300 charging cycles
Casing safety standard	IP X8
Ambient temperature	During operation: +10°C to +40°C During storage and transport: -20°C to +45°C
Max. relative humidity	During operation: 100% During storage and transport: 90%



Mindestabnahme: 5 Stück
Minimum purchase: 5 pieces
Cantidad minima: 5 unidades

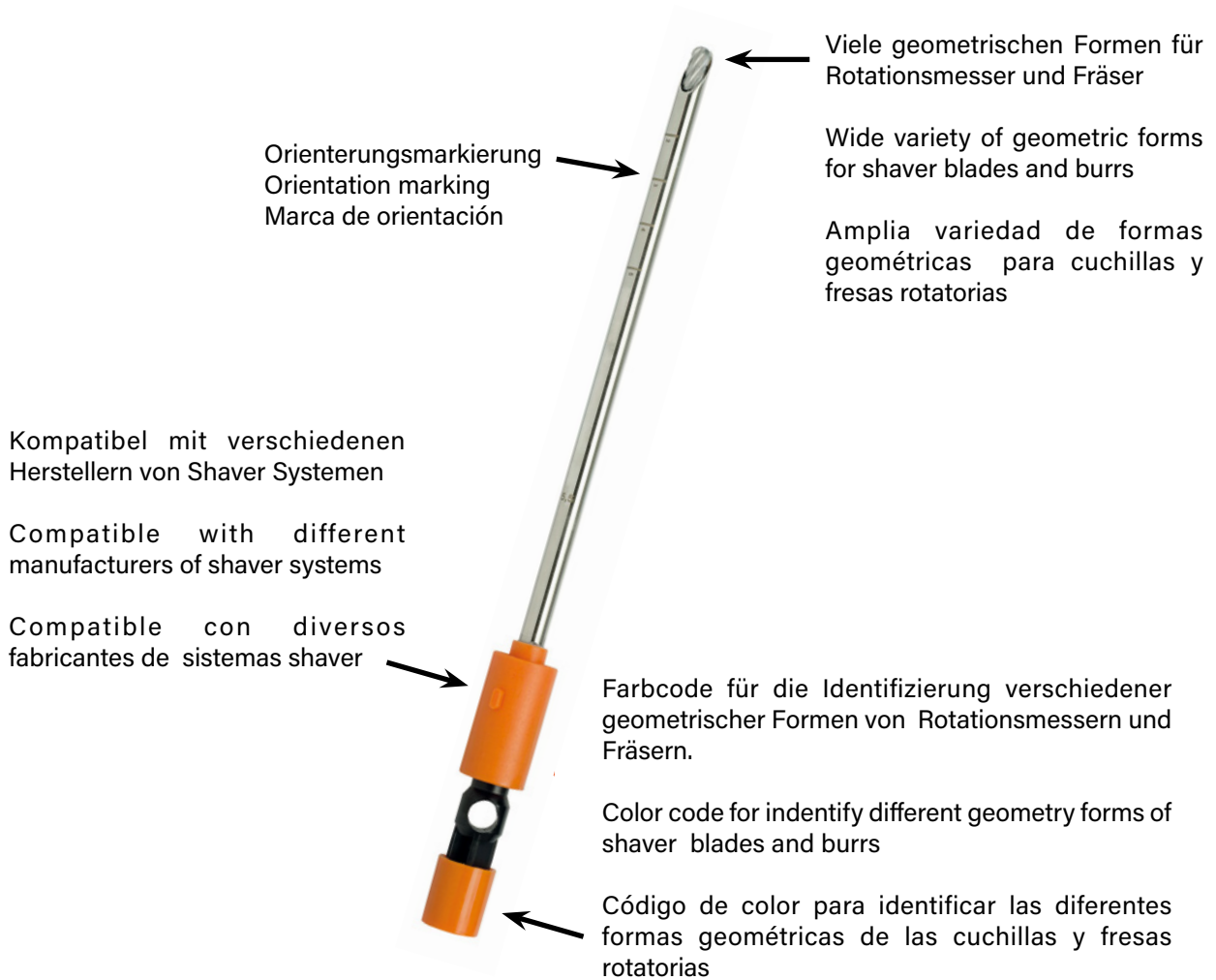









Hinweis: die Markierung ist hilfreich für die Orientierung, nicht zum Messen.
Note: the marking is useful for orientation, not for measure.
Nota: el marcado solo es útil para orientación, no para medir.

Auf Anfrage auch lieferbar in single use, steril
on request available in single use, steril
a petición disponible en desechable y esteril

Shaver blades for Reda, Linvatec, Concept, Arthrex, Atlantec

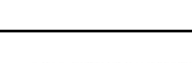

Länge 130 mm, autoklavierbar, wiederverwendbar
 Length 130 mm, autoclavable, reusable
 Largo 130 mm, autoclavable, reusable

	Beschreibung Description Descripcion	Ø 3,4 mm	Ø 4,2 mm	Ø 5,5 mm	
	Aggressive Full-Radius Resector	R452-034130-001	R452-042130-001	R452-055130-001	● ●
	Double Aggressive Full-Radius		R452-042130-002	R452-055130-002	○ ●
	Meniscus Cutter	R452-034130-003	R452-042130-003	R452-055130-003	● ●
	End Cutter		R452-042130-004	R452-055130-004	○ ●
	Full-Radius Resector	R452-034130-005	R452-042130-005	R452-055130-005	○ ○
	Incisor	R452-034130-006	R452-042130-006	R452-055130-006	● ●
	Cutter		R452-042130-007		● ○
	Round Burr		R452-042130-008	R452-055130-008	● ●
	Tapered Burr			R452-055130-009	● ●
	Oval Burr		R452-042130-010	R452-055130-010	● ●

89
89258-2545

98
98002-0644

R
R 310.2045
R 311.2045
R 312.2045
R 313.2045
R 320.2045
R 321.2045
R 322.2045
R 323.2045
R 330.2045
R 331.2045
R 332.2045
R 333.2045
R 340.2045
R 341.2045
R 342.2045
R 343.2045
R 350.2045
R 351.2045
R 352.2045
R 353.2045

R019
R019-000000-0143
R019-000000-0243
R019-000000-02544
R019-000000-03044
R019-931243

R400
R400-019069-03042
R400-019102-03042
R400-027110-0006
R400-027110-0306
R400-027175-0008
R400-027175-0308
R400-027175-0708
R400-027188-00010
R400-027188-03010
R400-027188-07010
R400-040175-0004
R400-040175-0304
R400-040175-0454
R400-040175-0704

R410-027110-0017
R410-027110-0027
R410-027110-0037
R410-027175-0019
R410-027175-0029
R410-027175-0039
R410-027188-00111
R410-027188-00211
R410-027188-00311
R410-040175-0015
R410-040175-0025

R410-040175-0035

R413
R413-027110-0307
R413-027110-0707
R413-027175-0309
R413-027175-0709
R413-027188-03011
R413-027188-07011
R413-040175-0305
R413-040175-0705

R414
R414-027110-0307
R414-027110-0707
R414-027175-0309
R414-027175-0709
R414-027188-03011
R414-027188-07011
R414-040175-0305
R414-040175-0705

R430
R430-028130-00029
R430-034130-00029

R431
R431-028130-00029
R431-034130-00029

R432
R432-028130-00029
R432-034130-00029

R433
R433-028130-00029
R433-034130-00029

R434
R434-028130-00029
R434-034130-00029

R435
R435-028130-00029
R435-034130-00029

R436
R436-028130-00030
R436-028130-00130
R436-034130-00030
R436-034130-00130
R436-042150-21031
R436-042150-31031
R436-042150-41031

R437
R437-022130-00031

R438
R438-035130-00031

R439
R439-034130-00032
R439-034130-01532
R439-034130-04532
R439-034130-10032
R439-034130-11532
R439-034130-14532
R439-034130-20032
R439-034130-30032
R439-034130-31032

R440
R440-028130-00012
R440-028130-00712
R440-028130-01512
R440-028130-03012
R440-028130-04512
R440-028130-10712
R440-028130-11512
R440-028130-13012
R440-028130-14512
R440-028130-20013
R440-028130-20713
R440-028130-21513
R440-028130-23013
R440-028130-24513
R440-028130-30713
R440-028130-31513
R440-028130-33013
R440-028130-34513
R440-034130-00012
R440-034130-00712
R440-034130-01512
R440-034130-03012
R440-034130-04512
R440-034130-10712
R440-034130-11512
R440-034130-13012
R440-034130-14512
R440-034130-20013
R440-034130-20713
R440-034130-21513
R440-034130-23013
R440-034130-24513
R440-034130-30713
R440-034130-31513
R440-034130-33013
R440-034130-34513
R440-034130-54524
R440-034130-59024
R440-034130-74524
R440-034130-79024

R441
R441-028130-00014
R441-028130-00714
R441-028130-01514
R441-028130-03014
R441-028130-04514
R441-028130-10714
R441-028130-11514
R441-028130-13014
R441-028130-14514

R441-028130-20017
R441-028130-20717
R441-028130-21517
R441-028130-23017
R441-028130-24517
R441-028130-30717
R441-028130-31517
R441-028130-33017
R441-028130-34517
R441-028130-40015
R441-028130-40715
R441-028130-41515
R441-028130-43015
R441-028130-44515
R441-028130-60715
R441-028130-61515
R441-028130-63015
R441-028130-64515
R441-034130-00014
R441-034130-00714
R441-034130-01514
R441-034130-03014
R441-034130-04514
R441-034130-10714
R441-034130-11514
R441-034130-13014
R441-034130-14514
R441-034130-20017
R441-034130-20717
R441-034130-21517
R441-034130-23017
R441-034130-24517
R441-034130-30717
R441-034130-31517
R441-034130-33017
R441-034130-34517
R441-034130-40015
R441-034130-40715
R441-034130-41515
R441-034130-43015
R441-034130-44515
R441-034130-54524
R441-034130-59024
R441-034130-60715
R441-034130-61515
R441-034130-63015
R441-034130-64515
R441-034130-74524
R441-034130-79024

R442
R442-028130-00016
R442-028130-00716
R442-028130-01516
R442-028130-03016
R442-028130-04516
R442-028130-10716
R442-028130-11516
R442-028130-13016
R442-028130-14516
R442-034130-00016
R442-034130-00716
R442-034130-01516
R442-034130-03016

R442-034130-04516
R442-034130-107.....16
R442-034130-11516
R442-034130-13016
R442-034130-14516

R443

R443-034130-00019
R443-034130-00719
R443-034130-01519
R443-034130-03019
R443-034130-04519
R443-034130-10719
R443-034130-11519
R443-034130-13019
R443-034130-14519
R443-034130-20019
R443-034130-20719
R443-034130-21519
R443-034130-23019
R443-034130-24519
R443-034130-30719
R443-034130-31519
R443-034130-33019
R443-034130-34519
R443-034130-50725
R443-034130-51525
R443-034130-53025
R443-034130-54525
R443-034130-59025
R443-034130-60725
R443-034130-61525
R443-034130-63025
R443-034130-64525
R443-034130-70725
R443-034130-71525
R443-034130-73025
R443-034130-74525
R443-034130-79025
R443-034130-80725
R443-034130-81525
R443-034130-83025
R443-034130-84525

R444

R444-034130-00018
R444-034130-00718
R444-034130-01518
R444-034130-03018
R444-034130-04518
R444-034130-10718
R444-034130-11518
R444-034130-13018
R444-034130-14518
R444-034130-20018
R444-034130-20718
R444-034130-21518
R444-034130-23018
R444-034130-24518
R444-034130-30718
R444-034130-31518
R444-034130-33018
R444-034130-44523

R446

R446-034130-00020
R446-034130-00720
R446-034130-01520
R446-034130-03020
R446-034130-04520
R446-034130-10720
R446-034130-11520
R446-034130-13020
R446-034130-14520
R446-034130-20020
R446-034130-20720
R446-034130-21520
R446-034130-23020
R446-034130-24520
R446-034130-30720
R446-034130-31520
R446-034130-33020
R446-034130-34520

R447

R447-034130-00021
R447-034130-00721
R447-034130-01521
R447-034130-03021
R447-034130-04521
R447-034130-10721
R447-034130-11521
R447-034130-13021
R447-034130-14521

R448

R448-034130-00022
R448-034130-01522
R448-034130-04522
R448-034130-14522
R448-034130-20022
R448-035130-60023
R448-035130-80023

R449

R449-035100-09026
R449-035100-19026

R450

R450-028130-00027
R450-028130-03027
R450-028130-04527
R450-028130-13027
R450-028130-14527
R450-034130-00027
R450-034130-03027
R450-034130-04527
R450-034130-13027
R450-034130-14527
R450-034130-24527
R450-034130-34527

R451

R451-034130-00028
R451-034130-03028
R451-034130-04528
R451-034130-13028

R451-034130-14528

R452

R452-034130-00149
R452-034130-00349
R452-034130-00549
R452-034130-00649
R452-042130-00149
R452-042130-00249
R452-042130-00349
R452-042130-00449
R452-042130-00549
R452-042130-00649
R452-042130-00749
R452-042130-00849
R452-042130-01049
R452-055130-00149
R452-055130-00249
R452-055130-00349
R452-055130-00449
R452-055130-00549
R452-055130-00649
R452-055130-00849
R452-055130-00949
R452-055130-01049

R470

R470-045000-00040
R470-045083-00040
R470-045083-00140
R470-045083-00240

R471

R471-032070-00041
R471-032070-00341
R471-032070-02441
R471-032070-19941
R471-045070-00041
R471-045070-00341
R471-045070-02441
R471-045070-19941

R472

R472-032070-00041

R480

R480-020110-00033

R481

R481-020110-00033

R485

R485-020110-00033

R4186

R486-020110-00033

R487

R487-020110-00033

R490

R490-025110-4342

R490-030110-0334
R490-030110-0534
R490-030110-1134
R490-030110-1234
R490-030110-1334
R490-030110-1434
R490-030110-1534
R490-030110-1634
R490-030110-1735
R490-030110-2135
R490-030110-3135
R490-030110-3235
R490-030110-3335
R490-030110-4335
R490-030110-4535
R490-030110-4735
R490-030110-5135
R490-030110-5235

R492

R492-000000-00037
R492-030110-0036
R492-030110-0336
R492-030110-0436
R492-030110-1136
R492-030110-1236
R492-030110-1336
R492-030110-1436
R492-030110-1536
R492-030110-1636
R492-030110-1737
R492-030110-2137
R492-030110-3137
R492-030110-3237
R492-030110-4337
R492-030110-4537
R492-030110-4737
R492-030110-5137
R492-030110-5237

R494

R494-030110-0339
R494-030110-0439
R494-030110-1139
R494-030110-1239
R494-030110-1339
R494-030110-1439
R494-030110-1539
R494-030110-1639
R494-030110-1738
R494-030110-2138
R494-030110-3138
R494-030110-4338
R494-030110-4538
R494-030110-5139
R494-030110-5239

RED-800

RED-8002-1047
RED-8005-2F47
RED-8005B-3F47
RED-8008-11H47

Index Deutsch

A

Antrumstanze23
Adapter 40
Arthroskope..... 4, 6, 8, 10, 42
Arthroskopieschäfte5, 7, 9, 11
Arthroskopie-Shaver..... 46

B

Biopsiestanzen.....24, 25, 30

C

Container45

E

Endoskope 4, 6, 8, 10, 42

F

Fadenzangen32
Faßzangen.....29
Fußschalter.....47

H

Handstück47
Hakenschere 27-28
Hakenstanzen.....12-26
Handinstrumente 34-39

I

Inflow Kanüle..... 40
Instrumente für 2. Einstich..... 33, 42

L

Lagerungs- und Sterilisierack.....45

M

Meniskusretraktor..... 31

O

Obturator.....5, 7, 9, 11, 40-42

R

Rotationsmesser und Fräser..... 48-49
Rotationszange26

S

Schere27-28, 33
Shaver-Konsole67
Spülkanüle41
Stanzen12-26

T

Trokarhülse 5, 7, 9, 11, 42

Z

Zangen 30-32
Zubehör44, 45

Index English

A

Accessories 44, 45
Adapter 40
Antrum Punch 23
Arthroscopes 4, 6, 8, 10, 42
Arthroscopic Shaver 46
Arthroscopy Sheath 5, 7, 9, 11

B

Biopsy punch 24, 25, 30

C

Container 45

E

Endoscopes 4, 6, 8, 10, 42

F

Footswitches 47
Forceps 30-32

G

Grasper 29

H

Hand Instruments 34-39
Handpiece 47
Hook Punches 12-26
Hook Scissors 27-28

I

Inflow Cannula 40
Instruments for 2nd Puncture 33, 42
Irrigation Cannula 41

L

Ligature Forceps 32

M

Meniscus retractor 31

O

Obturator 5, 7, 9, 11, 40-42

P

Punches 12-26

R

Rotary Punches 26

S

Scissors 27-28, 33
Shaver Blades & Burrs 48-49
Shaver Console 46
Storage- and sterilization rack 45

T

Trocar Sleeves 5, 7, 9, 11, 42

Index Español

A

Accesorios..... 44, 45
Adaptador..... 40
Artroscopios..... 4, 6, 8, 10, 42

C

Canula de irrigacion41
Canula Inflow 40
Contenedores.....45
Consola Shaver.....47
Cuchillas y fresas rotatorias..... 48-49

E

Endoscopios..... 4, 6, 8, 10, 42

I

Interruptores de pie47
Instrumentos manuales..... 34-39
Instrumentos para la
segunda perforacion..... 33, 42

M

Manga De Trocar 5, 7, 9, 11, 42

O

Obturadores5, 7, 9, 11, 40-42

P

Perforadore.....12-26
Pieza de mano.....47
Pinza Antrum23
Pinza cortante12-26
Pinza de biopsia24, 25, 30
Pinza rotatoria26
Pinzas 30-32
Pinzas de agarre.....29
Pinzas para ligadura.....32

R

Retractor de menisco 31
Soporto para
almacenaje y esterilizacion.....45

S

Shaver artroscópica 46

T

Tijera en forma de gancho 27-28
Tijeras27-28, 33

V

Vainas para artroscopia.....5, 7, 9, 11

Weitere Kataloge und Prospekte
Other cataloges and prospects

Hauptkatalog Chirurgische Instrumente
General catalog surgical instruments

Neurochirurgie
Neuro surgery

Plastische Chirurgie
Plastic surgery

HNO
ENT

Container Steriltechnik
Container Sterilization Technique

Endoskopie
Endoscopy

Orthopädie
Orthopedic

HERCULES® Drahtkneifzange
HERCULES® Wire Cutters

Titan Instrumente
Titanium Instruments



Gänsäcker 34
P.O. Box 131
D-78532 Tuttlingen
Germany



Fon +49 74 62.94 45-0
Fax +49 74 62.94 45-20
info@Reda-Instrumente.de
www.Reda-Instrumente.de